

Florida State University Libraries

Electronic Theses, Treatises and Dissertations

The Graduate School

2005

Self-Objectification and Exercise Behaviors: The Mediating Role of Social Physique Anxiety

Lise Melbye



THE FLORIDA STATE UNIVERSITY
COLLEGE OF EDUCATION

SELF-OBJECTIFICATION AND EXERCISE BEHAVIORS:
THE MEDIATING ROLE OF SOCIAL PHYSIQUE ANXIETY

By

LISE MELBYE

A Thesis submitted to the
Department of Educational Psychology and Learning Systems
in partial fulfillment of the
requirements for the degree of
Master of Science

Degree Awarded:
Summer Semester, 2005

The members of the Committee approve the thesis of Lise Melbye defended on June 15th, 2005.

Gershon Tenenbaum
Professor Directing Thesis

Alysia Roehrig
Committee Member

David Eccles
Committee Member

Approved:

Frances Prevatt, Chair, Educational Psychology and Learning Systems

The Office of Graduate Studies has verified and approved the above named committee members.

TABLE OF CONTENTS

List of Tables	v
List of Figures	vi
Abstract	vii
INTRODUCTION	1
1. LITERATURE REVIEW	3
Self-objectification.....	3
Social Physique Anxiety.....	5
Self-Objectification and Social Physique Anxiety.....	6
Social Physique Anxiety and Exercise Behavior	7
Self-Objectification and Exercise Behavior	9
Model of Self-Objectification, Social Physique Anxiety, and Exercise Behavior	9
Purpose of Study.....	10
Hypotheses	11
2. METHODS	12
Participants	12
Measurements	
Background Information.....	12
Self-Objectification Questionnaire.....	12
Objectified Body Consciousness Scales	13
Social Physique Anxiety Scale.....	14
Exercise Behavior Survey.....	15
Procedure	16
Statistical Analyses.....	16
3. RESULTS	18
Preliminary Analysis	18
Descriptive Statistics	19
Self-Objectification and Social Physique Anxiety.....	20
Self-Objectification and Exercise Behaviors.....	21

Measurement Models	25
Testing of Theoretical Models	30
Age and Self-Objectification.....	32
4. DISCUSSION	35
Potential Limitations and Future Research.....	43
APPENDIX A.....	45
APPENDIX B	46
APPENDIX C	47
APPENDIX D.....	48
APPENDIX E.....	49
APPENDIX F.....	50
APPENDIX G.....	53
APPENDIX H.....	54
REFERENCES	56
BIOGRAPHICAL SKETCH	60

LIST OF TABLES

1. Objectified Body Consciousness Scales (OBCS) 24-item Exploratory Factor Analysis loadings using oblim rotation.....	18
2. Internal Consistency of the Objectified Body Consciousness Scales (OBCS).....	19
3. Descriptive Statistics for Self-Objectification Questionnaire, Objectified Body Consciousness Scales, Social Physique Anxiety and Permissive/Protective Scale	20
4. Correlations between Self-Objectification (SOQ), Objectified Body Consciousness (OBCS), Social Physique Anxiety (SPAS), and Protective/Permissive Exercise Behavior (PPEB)	21
5. Pearson χ^2 and ϕ -Statistics Test of Exercise Behavior for Low and High Self-Objectification Women.....	25
6. Measurement and Structural Model Maximum Likelihood (ML) and Robust Estimation of Fit Indices	26
7. Mean scores for each age group on SOQ and OBCS Subscales.....	33
8. Tukey HSD Post-hoc paired comparisons of Self-Objectification Questionnaire (SOQ) and Objectified Body Consciousness Scales (OBCS) Surveillance Subscale among age groups.....	34

LIST OF FIGURES

1. Conceptual links among self-objectification, SPA, and exercise behaviors.....	10
2. Bar graph presenting weekly exercise activity of high and low objectification groups	22
3. Bar graph of exercise apparel preference of high and low objectification groups	23
3. Bar graph of exercise location preference of high and low self-objectification women	24
5. Cardio machine participation of high and low self-objectification women.....	24
6. Measurement model of OBCS surveillance and shame subscales with 15 loading items	27
7. Modified measurement model values for surveillance and shame OBCS subscales with 11 loading items	28
8. Measurement model values for SPAS	29
9. Measurement model for OBCS, surveillance and shame subscales, and SPAS	30
9. First model proposed with standardized regression values, loadings, and R ² values (* $p \leq .05$).....	31
11. Second model proposed with standardized regression values, loadings, and R ² values (* $p \leq .05$).....	32

ABSTRACT

Self-objectification and social physique anxiety (SPA) were investigated in relation to exercise behaviors. A theoretical model was developed that viewed SPA as a mediating variable between self-objectification and protective/ permissive exercise behaviors. Two hundred and ninety nine women within the age range of 18-74 participated in this study. They completed the Self-Objectification Questionnaire (SOQ), the Social Physique Anxiety Scale (SPAS), the Objectified Body Consciousness Scales (OBCS), and an exercise behavior survey. A moderate positive correlation was obtained between self-objectification and SPA. It has also been revealed that self-objectification decreases with age. Women that were high and low in self-objectification were found to have different exercise behaviors. Women low in objectification reported exercising more frequently each week, wearing more concealing exercise apparel, and preferring outdoors exercise locations when compared to women low in objectification, who preferred public facilities. A trend was also observed between the women on cardio-machine participation, with women high in objectification reporting more participation. The first model proposing self-objectification influenced protective/permissive exercise behaviors both directly and indirectly via SPA was supported overall. The only significant path, however, was from self-objectification to SPA. Protective/permissive exercise behaviors were unable to be predicted from either self-objectification directly, or via the mediating role of SPA. Similarly, the model involving objectified body consciousness, comprised of the variables of surveillance and shame, was supported overall. Again, however, the only path found to be significant was from objectified body consciousness to SPA. The protective/permissive exercise behaviors either directly or indirectly via SPA lacked support. Previous research has been extremely limited to compare self-objectification and exercise, and this study was further able to support the potential importance and impact the theory may have with exercise, especially with regards to women. This study also reaffirms the relationship between self-objectification and SPA, and pushes for further understanding of how the two theories interact as well as of issues involving health, the body and exercise.

CHAPTER 1: INTRODUCTION

Most people want to be considered desirable. Over the past few decades, modern western society has continually been slimming down its standard of beauty for women to that of ultra thin and toned (Hamilton & Waller, 1994; Klaczynski, Goold, & Mudry, 2004). Furthermore, society objectifies the sexuality of the female body (Archer, Iritani, Kimes, & Barrios, 1983; Sommers-Flanagan, Sommers-Flanagan, & Davis; 1993). Understanding the impact of the cultural ideal and the value placed upon the ideal by an individual is key to potentially gaining insight into their associated behavior.

Objectification theory helps lends insight on the potential impact of culture on how a person perceives and values themselves (Fredrickson & Roberts, 1997). In this theory it is postulated that people internalize the external cultural physique standards and body sexualization to varying degrees. People that have internalized the sexual objectification of the body, and the thin ideal to be their own standard, are considered to be high in self-objectification. As a result the person is more likely to view themselves through an external lens, as if they are an object. The damaging impact of self-objectification may appear in such forms as disordered eating, depression, sexual dysfunction, increased body shame, diminished cognitive resources, anxiety and more (Fredrickson & Roberts, 1997; Fredrickson, Roberts, Noll, Quinn, & Twenge, 1998; Miner-Rubino, Twenge & Fredrickson, 2002; Muehlenkamp & Saris-Baglana, 2002; Roberts & Gettman, 2004).

The type of anxiety of particular interest to this study is Social Physique Anxiety (SPA). SPA is the anxiety a person experiences as a result of the potential of their body being negatively evaluated by others (Hart, Leary & Rejeski, 1989). SPA has been associated with certain exercise motives and behaviors, typically ones that induce less attention (Brewer, Diehl, Cornelius, Joshua & Van Raalte, 2004; Crawford & Eklund, 1994; Eklund & Crawford, 1994; Finkenber, DiNucci, McCune, Chenette & McCoy, 1998; Frederickson & Morrison, 1996; Lantz, Hardy, & Ainsworth, 1997; Spink, 1992). Thus SPA is an important variable in understanding exercise behaviors within the framework of self-objectification theory.

Exercise has many potential positive results, including greater muscular strength, a higher cardiovascular threshold, improved overall health, and increased alertness (McArdle, Katch & Katch, 2001). Unfortunately, many women appear to exercise for reasons pertaining more towards physical appearance than health benefits, especially those with higher self-

objectification and SPA (Eklund & Crawford, 1994; Strelan, Mehaffe & Tiggemann, 2003). Understanding how a person feels and views themselves may lend insight into why they select certain behaviors, particularly regarding exercise. Limited research has examined the relationship between self-objectification and exercise behaviors, and only a moderate amount has done so for SPA. This study aims to determine if a relationship exists between self-objectification and exercise behaviors, and if potentially it is moderated by SPA. A better understanding of how people exercise in accord to how they perceive themselves can have great impact on possibly understanding how to promote and motivate people to exercise.

Chapter II presents a review of the theories of self-objectification, SPA and exercise behavior in depth. The impact of self-objectification and SPA on individual behaviors is discussed, and the links among the three concepts are examined. Finally, four hypotheses are generated regarding the relationships between self-objectification, SPA and exercise behavior.

CHAPTER II: LITERATURE REVIEW

In modern western society, the cultural ideal for the female body is that of a thin and beautiful one (Hamilton & Waller, 1994; Klaczynski, Goold, & Mudry, 2004). Most people, however, are unable to attain the perfect physique, despite hours of exercise and dieting. For many the combination of an individual's genetic make-up and the impossibility of appearing like the cultural ideal results in body dissatisfaction, eating disturbances and anxiety, even as young as eight years old (Holt & Ricciardelli, 2002; McAllister & Caltabiano, 1994; Ricciardelli & McCabe, 2001). Complicating the matter are images of women that often have a strong sexual undertone. The sexual objectification of the body in westernized societies has been shown to be more common for women than men (Archer, Iritani, Kimes, & Barrios, 1983; Sommers-Flanagan, Sommers-Flanagan, & Davis; 1993).

Self-Objectification

Women are aware of the potential of being looked at and judged by people around them. As a result, many women end up placing high priority on their physical appearance, deriving self-worth and happiness from it (Fredrickson & Roberts, 1997). This cultural ideal of an ultra trim female body and the enormous value placed on it by society compels women to internalize these external standards and hold them as their own. Fredrickson and Roberts (1997) objectification theory postulates that if a person has internalized the external sexual objectification of the female body, she is likely to view her body as if it were an object. If a woman observes her body by how others perceive it as opposed to viewing it through her own lens, this is known as self-objectification.

Self-objectification can be viewed as a state and personality disposition. State self-objectification occurs in situations where the potential observation of one's body is enhanced for a period of time. A possible moment of greater state self-objectification is evident when trying on more revealing clothing, such as a swimsuit (Fredrickson, Roberts, Noll, Quinn, & Twenge, 1998; Miner-Rubino, Twenge, & Fredrickson, 2002). Trait self-objectification occurs when an individual has strongly internalized the societal sexual standards, creating a persistent fixation on appearance.

Research indicates that women are more likely than men to experience trait self-objectification (Miner-Rubino, Twenge & Fredrickson, 2002). Furthermore, young women in particular appear to be the age group at the greatest risk for self-objectification and related

psychological symptoms (Slater & Tiggemann, 2002; Tiggemann & Lynch, 2001). In fact, self-objectification appears to diminish with age. Although body dissatisfaction appears to remain relatively stable throughout life, the pressure to conform to a specific ideal becomes less pervasive in the latter years of life. This eases appearance anxiety, habitual body monitoring, restrained eating and self-objectification (Tiggemann & Lynch, 2001).

Self-objectification has been linked to both psychological consequences and mental health risks (Fredrickson & Roberts, 1997; Fredrickson, Roberts, Noll, Quinn, & Twenge, 1998; Miner-Rubino, Twenge & Fredrickson, 2002; Roberts & Gettman, 2004). The mental health risks include disordered eating, depression and sexual dysfunction (Miner-Rubino, Twenge & Fredrickson, 2002). Muehlenkamp and Saris-Baglama (2002) surveyed undergraduate women and found a direct relationship between self-objectification and restrictive eating, bulimia, and depressive symptoms. The objectification theory contends that the concerns with food may arise as a consequence of the experienced heightened body shame. Even more persuasive of the impact on eating habits is the study by Fredrickson, Roberts, Noll, Quinn, & Twenge (1998) where the subjects were directly manipulated into state self-objectification by either wearing a swimsuit or a large sweater. The researchers were able to observe immediate restrained eating habits by those who were in the swimsuits compared to those in sweaters when offered a cookie.

The sexual consequence of self-objectification is related to the habitual monitoring those high in self-objectification commit. Fredrickson and Roberts (1997) hypothesized that women are unable to “get into” the sexual experience as a result of the occupation of mental resources by self-monitoring. Not only does self-objectification make the sexual act less enjoyable, but also women may experience a decrease in sexual desires due to the increase in body shame, body disgust and appearance anxiety (Roberts & Gettman, 2004).

Depression has been linked to anxiety (Tanaka-Matsumi & Kameoka, 1986). Likewise, self-objectification has been repeatedly linked to appearance anxiety (Fredrickson, Roberts, Noll, Quinn, & Twenge, 1998; Miner-Rubino, Twenge & Fredrickson, 2002; Slater & Tiggemann, 2002). The connection and implication of depression from self-objectification is postulated to be partly due to the fact that the body is only finitely modifiable, and the ability to attain the ideal body for many is impossible. Miner-Rubino, Twenge and Fredrickson (2002) hypothesized that despite the efforts an individual may take to achieve the ideal, much shame and disgust is held

towards the body. As a result, the person experiences increased anxiety about their body, as well as a potential to have feelings of learned helplessness and depression.

Associated psychological consequences include heightened body shame, body disgust, decreased “flow” states, insensitivity to bodily cues, diminished cognitive resources, and appearance anxiety (Miner-Rubino, Twenge & Fredrickson, 2002). Shame is considered to be a moral emotion, one that is intended to promote individuals to adhere to society’s standards. Since those who are high in self-objectification do not feel they have achieved the cultural standard, it is reasonable to assume they would be experiencing greater body shame than those who are lower in self-objectification (Fredrickson, Roberts, Noll, Quinn & Twenge, 1998; Miner-Rubino, Twenge & Fredrickson, 2002).

Disgust is also an emotion that has been socially developed. The standards set by society of what is deemed acceptable become internalized in the individuals. If certain actions are outside of the cultural norm, society deems them to be disgusting, such as the scenario of chewing with the mouth open. Those high in self-objectification are likely to feel as if they have violated a socio-moral standard by failing to achieve the ideal body, creating body disgust (Roberts & Gettman, 2004).

Diminished cognitive resources were noted by Fredrickson, Roberts, Noll, Quinn and Twenge (1998). The researchers had the female participants wear either a swimsuit or sweater while completing math task. As a result of the increase in the subject’s state anxiety while wearing a swimsuit, participant’s performance on the math task was hindered due to the preoccupation of their cognitive resources that were monitoring their bodies. Women wearing a sweater were not in a state of self-objectification, allowing them to perform at a higher level. The repercussions of decreased “flow” states and insensitivity to bodily cues stem from similar veins. Due to the occupation of cognitive resources and the dependence on external responses, it is postulated that women high in self-objectification would be less able to detach and reach the internal state of flow (Miner-Rubino, Twenge & Fredrickson, 2002). Likewise, with such attention focused externally, the women become less in tune with their bodies (Daubenmier, 2002; Miner-Rubino, Twenge & Fredrickson, 2002).

Social Physique Anxiety

Research has delved into SPA in a variety of contexts. SPA has been linked repeatedly to drive for thinness, perfectionism, bulimic symptomology, and body dissatisfaction (Diehl,

Johnson, Rogers & Petrie, 1998; Haase, Prapavessis & Owens, 2002; Krane, Stiles-Shiple, Waldron & Michalenok, 2001; Thompson & Chad, 2002). Haase, Prapavessis and Owens (2002) investigated the relationship between perfectionism and SPA. After surveying male and female elite athletes on their perfectionist tendencies and SPA, they noted negative perfectionism was moderately positively correlated with SPA. Negative perfectionism is when a person strives to reach a specific goal in order to avoid unpleasant consequences, such as achieving a certain physique in order to avoid disapproval from others.

SPA has been linked with bulimic symptomatology more so than with anorexic. This is believed to be possibly due to the increased social concern, an important factor in SPA, that is typically seen with bulimics as opposed to anorexics (Diehl, Johnson, Rogers & Petrie, 1998). Drive for thinness, which has a strong relationship with an intense fear of fatness, has further been highly associated with SPA (Hausenblas & Mack, 1999; Krane, Stiles-Shiple, Waldron, Michalenok, 2001). Body dissatisfaction and SPA have been shown to have a positive relationship repeatedly (Bartlewski, Van Raalte & Brewer, 1996; Hausenblas & Mack, 1999; Russell & Cox, 2003; Thompson & Chad, 2002). Body dissatisfaction is considered to be a key dynamic in the initiation and maintenance of weight loss (Garner, 1991).

Further, SPA has been noted to be more prevalent among women than men (Haase, Prapavessis & Owens, 2002; Hart, Leary, & Rejeski, 1989). The cultural ideal is postulated as a possible causal factor for the marked differences between the two sexes (Brownell, 1991). The inability to attain the extreme societal ideal is theorized to contribute to the higher levels of anxiety exhibited by women.

Self-Objectification and Social Physique Anxiety

Of particular interest to this study is the relationship between self-objectification and appearance anxiety. Consistently studies have shown that women who score high on self-objectification experience greater anxiety surrounding their appearance (Roberts & Gettman, 2004; Slater & Tiggemann, 2002). The potential evaluation of one's body may lead some women to experience high levels of anxiety, especially regarding their body's adherence to the cultural thin ideal (Roberts & Gettman, 2004). SPA has also been positively correlated with self-objectification (Calogero, 2004). SPA is defined as the anxiety a person experiences when they perceive their bodies as being or having the potential of being negatively evaluated by

others (Hart, Leary & Rejeski, 1989). SPA is similar to appearance anxiety, however, the focus pertains to the physique rather than the overall appearance.

Social Physique Anxiety and Exercise Behavior

Research has recently begun to look into the relationship of SPA and exercise behaviors. Exercise behavior is a person's typical pattern of fitness activity participation. This includes variables such as location of exercise, mode of exercise, apparel worn during exercise, group or individual activity, time of exercise, and exercise adherence just to name a few. Although this topic has received a decent amount of attention, many of the research findings have been mixed.

The desired exercise environment for those with higher levels of SPA appears to be one that is private as opposed to public (Spink, 1992). This is theorized to be a coping method to decrease anxiety by exercising in private, such as at home, in that the solitude reduces the potential of being negatively evaluated. When an exerciser with high SPA does participate in a group fitness class, however, they typically prefer spots away from attention, such as in the back of a gym or classroom (Brewer, Diehl, Cornelius, Joshua & Van Raalte, 2004).

Exercise adherence and SPA share a unique relationship. It appears that high SPA is indicative of either minimal or extreme commitment behavior (Finkenber, DiNucci, McCune, Chenette & McCoy, 1998; Frederickson & Morrison, 1996; Lantz, Hardy, & Ainsworth, 1997). To support the negative relationship between SPA and exercise adherence, Finkenber et al. looked into the relationship among kinesiology majors, athletes, and control participants. An inverse relationship was noted, however, the researchers were unable to ascertain if the commitment levels were a result of required activity, potentially confounding the results. Lantz, Hardy, and Ainsworth explored the relationship between SPA and exercise behaviors among the general population. After having over 300 subjects complete the SPA scale, the Minnesota Heart Health Physical Activity Questionnaire, and the Beck Depression Inventory, the researchers revealed a negative relationship between SPA and exercise behavior. The observation indicated those higher in SPA were less likely to participate in physical exercise, possibly due to the potential exercise brings in negative evaluation. They further noted the relationship between exercise adherence and SPA was moderated by age and gender, with older females with high SPA having the lowest commitment to exercise. Frederick and Morrison (1996), however, noted a positive relationship between SPA and exercise adherence. Unlike the other findings, the researchers found that those high in SPA reported the greatest number of days per week that they

exercise compared to those low. People high in SPA may potentially be dependent upon exercise in order ease the potential of negative evaluation. Clearly the research findings are mixed regarding the issue of SPA and exercise adherence.

Women typically have higher SPA than men (Haase, Prapavessis & Owens, 2002; Hart, Leary, & Rejeski, 1989). In recent years, women-only sections and fitness centers have become popular exercise locations. A couple of studies have looked into the relationship between SPA and women-only workout sections or entire gyms (Walton & Finkenberg, 2002; Yin, 2001). Yin investigated the attitudes of female exercisers towards women-only sections of gyms and their SPA levels. Participants utilizing the women only section of the gym were found to have higher levels of SPA than those in the co-ed section. It was postulated that the women-only environment eases the concerns of potential evaluation, particularly from men. Calogero's (2004) findings indicated that the anticipation of the male gaze was noted to produce higher levels of SPA than that of a female gaze. Conversely, when Walton and Finkenberg (2002) compared SPA of women-only fitness center attendees to those of a co-ed center, they found no difference in SPA levels. Interestingly, they did find women-only attendees rated the impact of the make-up of members on gym preference significantly higher than those at a co-ed location.

The type of exercise apparel also appears to be a reflection of SPA. Those with greater SPA preferred to wear items of clothing that are bulkier in comparison to those with low SPA levels (Brewer, Diehl, Cornelius, Joshua & Van Raalte, 2004; Crawford & Eklund, 1994; Eklund & Crawford, 1994). Wearing looser clothes may be a way that people with heightened levels of SPA cope as the apparel may discourage potential evaluation of their bodies. However, a study by Krane, Stiles-Shipley, Waldron and Michalenok (2001) found no such relationship. In their study, the researchers compared SPA scores and exercise attire of athletes and exercisers. They found that the style of clothing worn, baggy or revealing, had no relation to the type of participant, either an athlete or exerciser, or to their level of SPA.

The reasons for exercise and SPA have also been investigated. Eklund & Crawford (1994) noted that those who exercised for health reasons had lower SPA than those who participated for appearance reasons. Likewise, Frederick and Morrison (1996) observed those high in SPA were motivated to exercise for more extrinsic reasons than those that were low in SPA. Further, they also found that people high in SPA appeared to choose exercise modes that emphasized fitness more than individually or team based sports.

Self-presentation and SPA in exercise has been examined. Self-presentation is the method in which people attempt to manage their appearance in order to control the potential of being negatively evaluated (Schlenker & Leary, 1982). Self-presentation has been linked with high and low exercise adherence levels (Leary, 1992). Further, self-presentation has been associated with aesthetic motivational reasons for exercise, a preference for private locations while exercising, and lower physical self-efficacy (Hausenblas, Brewer, & Van Raalte, 2004).
Self-Objectification & Exercise Behavior

Self-objectification has only recently been introduced into the exercise domain (Daubenmier, 2002; Strelan, Mehaffey & Tiggemann, 2003). Many of the variables previously associated to self-objectification are ones that also have relationships in the exercise realm, such as those of body shame, “flow”, body disgust, and disordered eating. Strelan, Mehaffey and Tiggemann (2003) examined the mediating role of reasons for exercise between self-objectification, body esteem, and self-esteem among university fitness center attendees. They found that those experiencing higher levels of self-objectification exercised for appearance oriented reasons, while those with lower scores exercised for health benefits. Further, the level of body dissatisfaction and body esteem and self-esteem were all found to be lower among those who were high in self-objectification than their counterparts.

Daubenmier (2002) conducted the only comparative study with self-objectification and exercise behaviors, comparing Hatha yoga participants and body-oriented exercisers. Hatha yoga is a mind-body centered exercise, unlike the majority of exercise that is body-oriented, such as aerobics. Interestingly, Daubenmier (2002) found that the Hatha yoga participants scored significantly lower on self-objectification and the frequency of which they compared their body to others, but higher on body satisfaction than the participants of body-oriented activities. The focus by yoga on attenuating to the body and mind appears to have significant impact on the overall being (Daubenmier, 2002).

A Model of Self-Objectification, SPA and Exercise Behaviors

A positive relationship between self-objectification and SPA has been noted by Calogero (2004). Furthermore, certain exercise behaviors have been noted to coincide with various levels of SPA. Those higher in SPA appear to wear baggier uniforms, prefer exercising in private locations or further in the back of public locales, exercise for extrinsic reasons, and either exhibit extremely low or extremely high adherence (Brewer, Diehl, Cornelius, Joshua & Van Raalte,

2004; Crawford & Eklund, 1994; Eklund & Crawford, 1994; Finkenber, DiNucci, McCune, Chenette & McCoy, 1998; Frederickson & Morrison, 1996; Lantz, Hardy, & Ainsworth, 1997; Spink, 1992). Based on these findings, it is suggested that self-objectification, SPA, and exercise behavior share causal links presented in Figure 1.

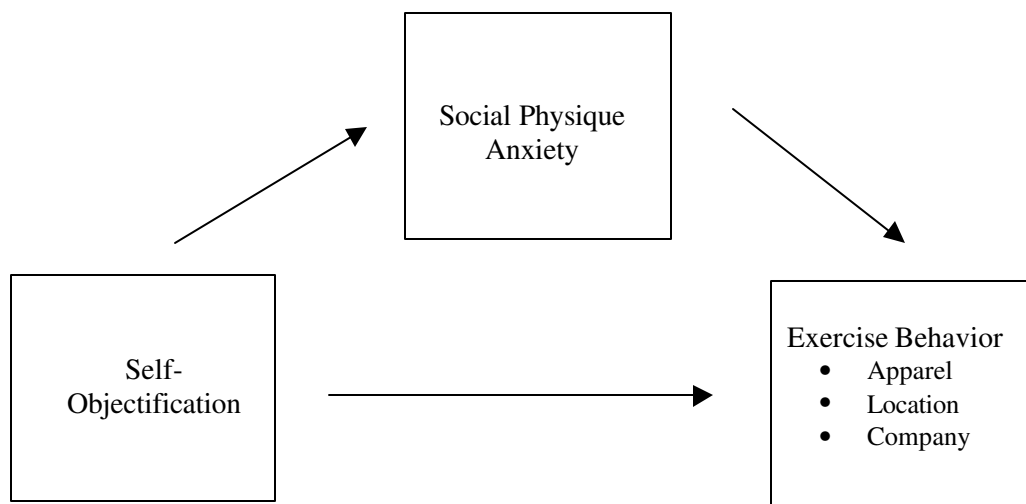

Figure 1. Conceptual links among self-objectification, SPA, and exercise behaviors.

The conceptual framework shows that self-objectification relates directly to certain exercise behaviors. SPA is conceptualized as a mediator between self-objectification and specific exercise behaviors. Thus, self-objectification has both direct and indirect (via SPA) effect on exercise behavior. For instance, self-objectification may lead to particular exercise behaviors, but also affect these behaviors indirectly by affecting SPA. In particular, the exercise behaviors most likely to be affected by self-objectification and SPA are exercise apparel, location of exercise adherence, mode of exercise and the time of day that the person participates in exercise.

Purpose of Study

Research involving self-objectification and exercise is extremely limited. A decent amount of research has investigated SPA and exercise behavior, but none has sought to determine if SPA has a mediating role between self-objectification and exercise behavior. This study is intended to determine the relationship between self-objectification and exercise behaviors, and examine the mediating role of SPA within a larger conceptual framework.

Hypotheses

1. Self-objectification will correlate moderately to strongly with SPA.
2. Women high in self-objectification will show a preference for baggier clothing, exercising in private rather than public environments, having extremely high or extremely low exercise adherence, prefer working out at times earlier or later in the day with less exercise traffic, chose modes of exercise that are more body-oriented and less revealing attire required (cardio machines, running, aerobic classes) than women low in self-objectification. In contrast, women low in self-objectification are predicted to be more likely to wear more revealing clothing, enjoy working out in public locales, exercise during peak hours, have average adherence, and participate in activities that may require more revealing clothing or less focused on the appearance (swimming, yoga, karate, etc.) than those high in self-objectification.
3. Exercise behaviors will be determined by both self-objectification and SPA.
4. Self-objectification will be higher among the younger women (18-24) than among the older women (25-34 and 35 and up).

CHAPTER III: METHODS

Participants

Two hundred and ninety-one women from a Southeastern city in the United States participated in the study. Locations the participants were gathered at included the public library, several public dog parks, the university student union, the local airport, a local shopping center, and a local park. They ranged in age from 18-76 years ($M = 29.27$, $SD = 11.50$); 81.1% of the subjects were white, 11.7% African-American, 3.8% Hispanic, 2.4% Asian and 1% percent chose not to answer; 49.1% of the sample were students, 47.1% were professionals, 3.8% were either retired, unemployed or chose not to answer.

Measurements

Several questionnaires were administered to the participants:

Background Information (Appendix D). Participants were asked to indicate their age, gender, occupation, and race.

Self-Objectification Questionnaire (SOQ, Fredrickson, Roberts, Noll, Quinn & Twenge, 1998; Appendix E). Self-objectification was measured by two instruments. The first measure, SOQ, is aimed at assessing whether a person views his/her body in an objectified, appearance-based manner or in a non-objectified, competence-based term. Participants were asked to rank 10 body-attributes in order of importance to them. Five of the items pertain to appearance-based attributes (sex appeal, firm/sculpted muscles, weight, physical attractiveness and measurements), while the other five relate to competence based physical attributes (energy level, health, strength, physical fitness, and physical coordination). Scores were calculated by assigning value to the rankings, with the most important receiving 10, and the least important attribute receiving 1. Next, the appearance oriented attribute rankings were added together for one total, and the competence based ones for second sum. Competence-based values were subtracted from appearance-based ones, resulting in a score between 25 to -25. The higher the score, the more the subject objectifies. Likewise, the lower the score, the more the person views their body based on competence terms, indicating the participant has lower self-objectification (Fredrickson, Roberts, Noll, Quinn & Twenge, 1998; Noll & Fredrickson, 1998). Internal consistency (alpha) for the SOQ was reported as 0.87 - 0.91. Convergent and divergent validity were established for the SOQ through positive correlations with appearance anxiety, $r = 0.56$,

and body size dissatisfaction, $r = 0.33$. Body shame and self-objectification were found to be positively correlated at $r = 0.54$ (Noll, 1996).

Objectified Body Consciousness Scale (OBCS, McKinley & Hyde, 1996; Appendix F).

The OBCS is a 24-item Likert-type scale survey containing three subscales of body shame, body surveillance, and body control. Participants were asked to indicate to what extent the statement agrees with how they feel about their bodies, from 1 (*not at all*) to 7 (*strongly agree*), and NA being if they never experience the particular statement. The OBCS was scored by summing together the participant's responses, with each subscale consisting of 8-items. Each scales' score range was between 0-56. The score was then divided by the total number of responses in the respective subscale, resulting in a score range between 0-7. The higher the score, the more the person is said to experience that particular subscale item of body shame, body surveillance or body control.

The body shame subscale determines if the person is higher or lower in body shame, with the higher score indicating the subject feels guilt for not attaining the cultural standard. It is also a measure of the degree to which a person has internalized the cultural physique standard. An example question of the body shame subscale is "I would be ashamed for people to know what I really weigh." The internal reliability for the body shame subscale is 0.75. McKinley and Hyde (1996) demonstrated construct validity by asking participants to rate the statements of the OBCS body shame subscale correspondence to societal standards. All of the items received at least half of the participants' agreement that they were representative of cultural standards for appearance. The items and their respective percentages of young women participant statement agreement were as follows: gaining weight (92.1%, $N = 256$), clothes style (64.4%, $N = 179$), not looking best (82.6%, $N = 230$), eating a large meal (79.9%, $N = 222$), and not being thin (95.0%, $N = 264$). Middle age women reported similar results. The body shame subscale and body-esteem were negatively correlated ($r = - 0.51$) (McKinley & Hyde, 1996).

The body surveillance subscale measures the extent to which a person is vigilant about their body. The higher the person scores, the more the person thinks about the body in terms of how it appears. An example question for the body surveillance subscale is, "I rarely compare how I look with how other people look." The internal reliability for the body surveillance subscale is 0.89. McKinley and Hyde (1996) established validity for the body surveillance subscale. Concurrent validity for the surveillance subscale was demonstrated through the

positive correlations with the Appearance Orientation Scale ($r = .64$), and the BCQ Public Body Scale ($r = .46$). A negative relationship between body esteem and the body surveillance subscale was also found lending support for discriminate validity ($r = -0.39$). Concurrent validity was established by correlating body surveillance subscale to the public self-consciousness scale ($r = .73$).

The body control subscale measures how much control a person believes they have over their body's appearance. If a person scores high on this subscale, it indicates he/she believes he/she has a great amount of control over their appearance, rather than a person who scores low and views genetics, for instance, playing a major role in appearance. An example question in the body control subscale is, "I think a person can look pretty much how they want to if they are willing to work at it." The internal reliability for the body control subscale was 0.72. Construct validity of the body control subscale was established through a one-way ANOVA comparing restricted and non-restricted eating groups. Participants were classified as restricted eating if they were currently or had in the past 6 months restricted their food intake. Results revealed that the participants in the restricted eating group had a stronger belief that they could control their appearance than those in the non-restricted eating group (McKinley & Hyde, 1996).

Social Physique Anxiety Scale (SPAS; Motl & Conroy, 2000; Appendix G). The SPAS consists of a 7-item Likert-type scale, a modified version of Hart, Leary and Rejeski's (1989) original 12-item SPAS. The SPAS measures the extent to which a person experiences anxiety regarding their physique in social situations. The participant ranks each item on a Likert-type scale ranging between 1 (*not at all*) to 5 (*extremely*), depending on the degree to which the particular statement is characteristic of them. A person's score was calculated by summing together the responses, noting question 5 is reverse scored. The scores ranged between 7-49. The higher the score, the more the person was considered to experience high levels of SPA. Example questions of the 7-item SPAS include, "Unattractive features of my physique/figure make me nervous in certain social settings" and, "I wish I was not so uptight about my physique/figure." The 7-item SPAS has a temporal stability of .94 (Scott, Burke, Joyner & Brand, 2004). Motl and Conroy (2000) examined the validity of the 7-item SPAS. Convergent validity was established through a positive relationship between the 7-item SPAS and the OBCS surveillance subscale ($r = 0.47$), a negative correlation between SPAS and perceived physical ability ($r = -0.31$), and physical self-presentational confidence ($r = -0.52$).

Exercise Behaviors Survey (Appendix H). Exercise behaviors were gathered by using a survey constructed by the researcher. Questions asked the participant to mark the answer that best represented their typical exercise preference for the particular behavior. The exercise behaviors that were included in the survey were: adherence, exercise apparel, exercises location, time of day of exercise participation, mode of exercise, and group versus individual exercise participation. Specific behaviors were then classified as either self-protective or self-permissive. The self-protective behaviors included baggier exercise apparel, private exercise locations (ie: at home), and exercising alone. The self-permissive behaviors included revealing exercise apparel, public exercise locales, and group participation. The items and scoring of the items determining permissive-protective behaviors were as follows:

Behaviors	Rankings
Apparel	1 – Very revealing
	2 – Moderately revealing, moderately concealing, wear either revealing or concealing
	3 – Very concealing
Location	1 – Gym/Public Facility
	2 – Outdoors
	3 – At home
Exercise Company	1 – Group not necessarily friends
	2 – With friends
	3 – Alone

Each item represents a behavior where the response ranges from 1 (*Self-permissive*) to 3 (*self-protective*). The scores on the 3 items were summed up to yield a score range between 3-9. The higher the score, the more self-protective behavior the woman partakes in when exercising. Likewise, the lower the score, the more self-permissive the exercise behavior. Only the three behaviors of exercise apparel, exercise company and exercise location were used in the self-protective/self-permissive classification section. These three behaviors represent the self-protective/self-permissive continuum, as each response can be reliably defined as either permissive or protective. The other behaviors, time of day, mode of exercise and exercise duration and frequency were less definitive as either a self-protective or self-permissive behavior. The exercise behavior of time of day was not utilized as the time the participant

exercised was not relevant to self-protective or self-permissive, mainly because it was contingent on the location of exercise as to whether it would be considered protective or permissive. Mode of exercise also was not included as classifying the activity strictly into one division or another. Finally, exercise adherence behavior was not tabulated into the scoring as categorization of duration and frequency of exercise was not considered to be either a self-protective or self-permissive behavior.

Procedure

Participants were gathered from many locations around the city including at the public library, several public dog parks, the university student union, the local airport, a local shopping center, and a local park. Participants were approached and read a consent form (Appendix C). They were asked to sign the consent form if they agree to the terms, understood the objectives of the study, the minimal risk associated with the study, their rights to withdraw at any time if they so choose, and what measures were taken to ensure their anonymity. Once the participants agreed to the terms and fully understand their rights, they were asked to voluntarily fill out a demographics sheet, the Self-Objectification Questionnaire, the Objectified Body Consciousness Scale, the Social Physique Anxiety Scale and the Exercise Behavior Survey. Completing the surveys took about 15-25 minutes. Upon completion of the surveys, participants were thanked and any further questions were answered. The participants were also asked if they would like a copy of the results upon completion of the study.

Statistical Analysis

To test the first hypothesis, a Pearson Product Moment Correlation between the SPAS and the three dimensions of the OBCS and the SOQ (PPMC) was estimated. To test the second hypothesis, the responses on each subscale of the OBCS as well as the SOQ were examined for their distribution. Prior to classifying the high and low self-objectification participants, the three subscales of the OBCS and the SOQ were subjected to a confirmatory factor analysis (CFA). Once a good fit of the model to the data was achieved, the latent self-objectification measure was determined, and then used for the classification of the high and low women on self-objectification. The upper third and the lower third of the distribution were classified as low objectification and high objectification, respectively. These two groups (high and low self-objectification) were contrasted to each other on each of the exercise behavior categories separately using a non-parametric χ^2 and phi statistics.

The third hypothesis was tested by correlating each of the SOQ, the 3 dimensions of the OBCS, and the SPA with the Permissive-Protective exercise behaviors. In addition, structural equation modeling (SEM) was performed to test the model linking self-objectification to exercise behaviors, directly and indirectly via the mediation of SPA. The model was considered to be recursive, meaning that there were no feedback loops in the causal directions. To test the proposed model, a confirmatory factor analyses was conducted to evaluate the construct validity of the measurement. The measurement models consisted of the SPA and OBCS, as well as of a model including both latent variables with multiple indicators. After the model had been statistically supported, the larger model fit proposing causal links among the variables was tested (Tate, 1998).

Specific fit indices were utilized to examine the proposed model's construct validity. The first fit index was χ^2 , where a perfect fit is supported with a value of zero. Second, the root mean square error of approximation (RMSEA) was used to measure the discrepancies between reproduced and observed covariances per degree of freedom (Browne & Cudeck, 1993). For the RMSEA a value of .05 is classified as a good fit. Finally, the comparative fit index (CFI), assigned a value between 0 and 1, with 1 being a perfect fit, and 0.90 being considered an acceptable value. In the SEM, the proposed model is compared with an independent model (Bentler, 1990). Paths may be found unfit, and other previously unaccounted for paths or correlations may be introduced and found to be more suitable. Modification to the proposed model may be necessary if poor indicator loadings, standardized residuals, or modification indices are found to exist.

To test the fourth hypothesis, the means of the three OBCS subscales and the total score on the SOQ were subjected to a one-way analysis of variance using the two age groups as the between subjects factor.

CHAPTER IV: RESULTS

Preliminary Analysis

Prior to testing the study's hypotheses, internal consistency coefficients and descriptive statistics were obtained for the scales used in the study. The reliability coefficient of the Social Physique Anxiety Scale (SPAS) ($\alpha = .88$) was strong and satisfactory. However, the subscales of the Objectified Body Consciousness Scales (OBCS) shared poor alpha coefficients ranging from .18 - .21. An Exploratory Factor Analysis (EFA) using oblimin rotation with $\lambda > 1.0$ criterion revealed seven factors accounting for 57.98% of the total variance. A 3-factor solution recommended in the literature resulted in a 38.91% variance accounted for. The 3-factor solution is presented in Table 1.

Table 1

Objectified Body Consciousness Scales (OBCS) 24-item Exploratory Factor Analysis loadings using oblim rotation

Item	Factor 1: Shame	Factor 2: Control	Factor 3: Surveillance
2. Can't control weight, must be a problem with me	.82*	.06	.15
5. Ashamed when haven't made effort to look best	.55*	.11	-.03
8. Feel like a bad person when not looking my best	.63*	.12	-.11
11. Ashamed for people to know what I weigh	.71*	.00	.05
16. Worry whether my clothes make me look good	.40*	-.03	-.28
17. When not exercising enough, question goodness	.46*	.20	-.14
23. Ashamed when not the size I think I should be	.74*	-.01	-.19
3. A person's stuck with the looks they're born with	-.04	.64*	.05
6. Much of being in shape is having the body type	.31	.46*	-.02
12. Don't have much control over my body's looks	.14	.58*	.04
15. Genes are large determinant of person's weight	.09	.65*	.10
18. Body will not change no matter all attempts	.12	.63*	.06
21. Can weigh what I'm supposed t if I try hard	.25	-.53*	.25
24. The shape you are in depends on your genes	.10	.62*	.02
1. I rarely think about how I look	-.04	.36	.40*
4. Comfort of clothes matters more than their looks	.03	.14	.53*
7. Think more about how my body feels than looks	-.12	.11	.58*
10. Rarely compare my looks to others	-.27	.14	.52*
13. During the day, I often think about how I look	.40	-.10	-.42*
19. Rarely worry about how I look to other people	-.36	.13	.48*
20. Think I'm ok even when I can't control weight	.16	-.20	.65*
22. Value what body does more than how it looks	-.15	-.10	.53*
9. A person can look how they want if work at it	.21	-.26	.31
14. Don't question goodness when not exercising	-.20	.00	.36

An item was considered to load onto a factor with magnitude of .40 or greater. The items within each factor were examined for common themes. The resulting contents were: (a) shame, (b) surveillance, and (c) control. A peer review confirmed the factor titles of surveillance, shame and control after reading the corresponding items without prior knowledge about the aims of the study and the structure of the OBCS. Items OBCS 9, “I think a person can look pretty much how they want to if they are willing to work at it,” and OBCS 14, “I never worry that something is wrong with me when I am not exercising as much as I should,” were removed due to poor loading on any factor. Internal consistency alpha coefficients were re-examined with the new factors, and after reversing items’ scoring formats. These coefficients are presented in Table 2. The coefficients ranged between .72 - .79.

Table 2

Internal consistency of the Objectified Body Consciousness Scales (OBCS)

Factor	# of Items	Cronbach Alpha
1. Surveillance	8	.76
2. Shame	7	.79
3. Control	7	.72

Descriptive Statistics

Descriptive statistics of the SOQ, OBCS subscales, SPAS, and the Permissive/ Protective Scale are presented in Table 3.

Table 3

Descriptive Statistics for Self-Objectification Questionnaire, Objectified Body Consciousness Scales, Social Physique Anxiety and Permissive/Protective Scale

Scale	Min	Max	Mean	SD	Skewness (Error)	Kurtosis (Error)
SOQ	-25.00	25.00	-4.91	12.63	.34 (.14)	-.63 (.29)
Surveillance	1.00	6.88	4.16	1.07	-.14 (.14)	-.25 (.29)
Shame	1.00	6.57	3.35	1.23	.34 (.14)	-.69 (.29)
Control	2.00	7.0	5.08	1.00	-.37 (.14)	-.30 (.29)
SPAS	7.00	35.00	19.88	6.45	.12 (.14)	-.80 (.29)
Permissive/ Protective	3.00	9.00	6.25	1.34	.10 (.14)	-.59 (.29)

Scores on the SOQ fell slightly more on the body competence end of the spectrum ($M = -4.91$, $SD = 12.63$). Body surveillance remained relatively neutral ($M = 4.16$), while body shame was rated slightly lower ($M = 3.35$), and body control moderately higher than average ($M = 5.08$) on a 1 to 7 ranged scale. All skewness values were within the -2 to $+2$ range, indicating accepted normality assumption. No value transformations were needed to examine the hypotheses due to the acceptable normality values.

Self-Objectification and Social Physique Anxiety

To test the first hypothesis stating a moderate to strong positive correlation between self-objectification and social physique anxiety, Pearson Product Moment Correlations (PPMC) were computed between the scores on the SOQ, the OBCS and the SPAS. The PPMC are presented in Table 4. A significant ($p = .01$) moderate positive correlation was obtained between SOQ and SPA ($r = .356$), supporting the first hypothesis. Surveillance and shame, two of the OBCS subscales, correlated positively and moderately to strongly with SPA ($r = .522$ for surveillance and $r = .703$ for shame). The control OBCS subscale failed to correlate with SPA ($r = -.114$).

Table 4

Correlations between Self-Objectification (SOQ), Objectified Body Consciousness (OBCS), Social Physique Anxiety (SPAS), and Protective/Permissive Exercise Behavior (PPEB)

Variable	SOQ	Surveillance	Shame	Control	SPA
SOQ					
Surveillance	.525*				
Shame	.384*	.538*			
Control	-.017	.034	-.20*		
SPA	.356*	.522*	.703*	-.114	
PPEB	-.061	-.099	.014	-.004	.053

* $p = 0.01$

Self-Objectification and Exercise Behavior

To test the second hypothesis that people high in self-objectification will exhibit different exercise behaviors than those low in self-objectification, classifications of high and low self-objectification groups were made. The top third of scorers on the SOQ distribution were considered to be the high self-objectification group, and bottom third were the low self-objectification group, respectively. Each group contained 97 women.

A non-parametric Pearson χ^2 analysis and ϕ -statistics were performed to link each of the exercise behaviors to SOQ (low vs. high). Results revealed high and low SOQ women differed significantly on frequency of exercise, $\chi^2(3, N = 194) = 10.231, p = .017$. Low self-objectification women reported more frequent exercise participation than the high self-objectification group. This is presented in Figure 2.

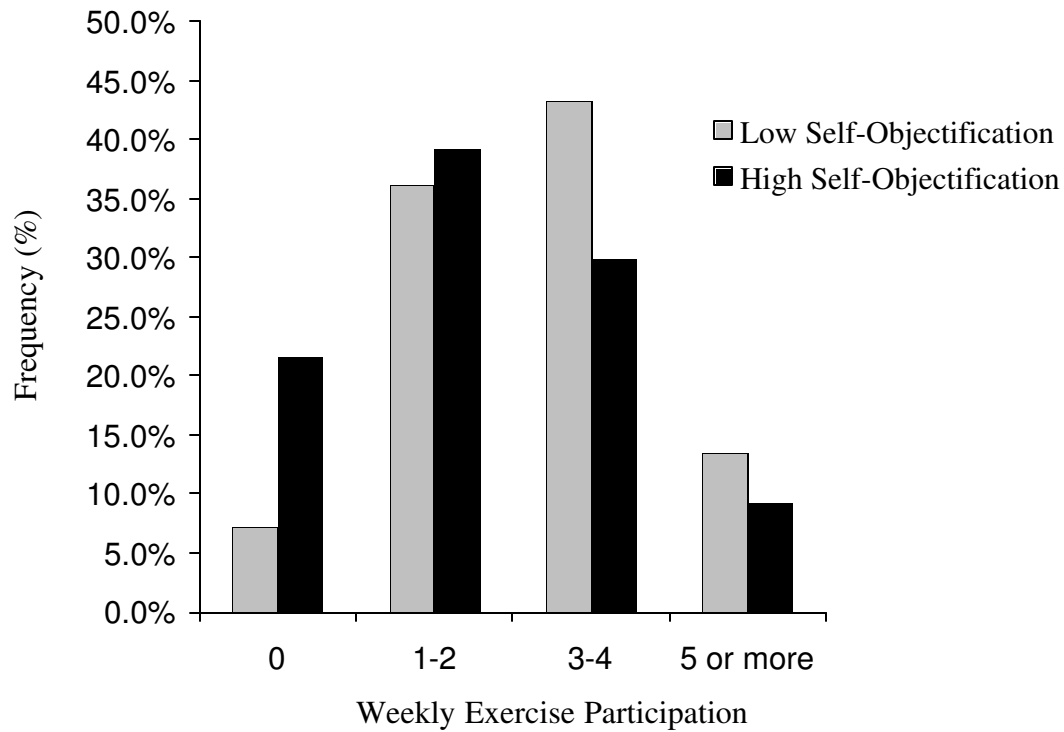

Figure 2. Bar graph presenting weekly exercise activity of high and low objectification groups.

Figure 2 illustrates that women low in self-objectification reported higher levels of weekly exercise participation, with 56% claiming adherence of at least 3 workouts a week, compared to only 39.2% the women high in self-objectification. In fact, 21.6% of women high in self-objectification did not exercise at all, compared to 7.2% of women low in self-objectification. The women high and low in self-objectification also significantly differed on exercise apparel, $\chi^2(4, N = 194) = 11.969, p = .018$. The differences are presented in Figure 3.

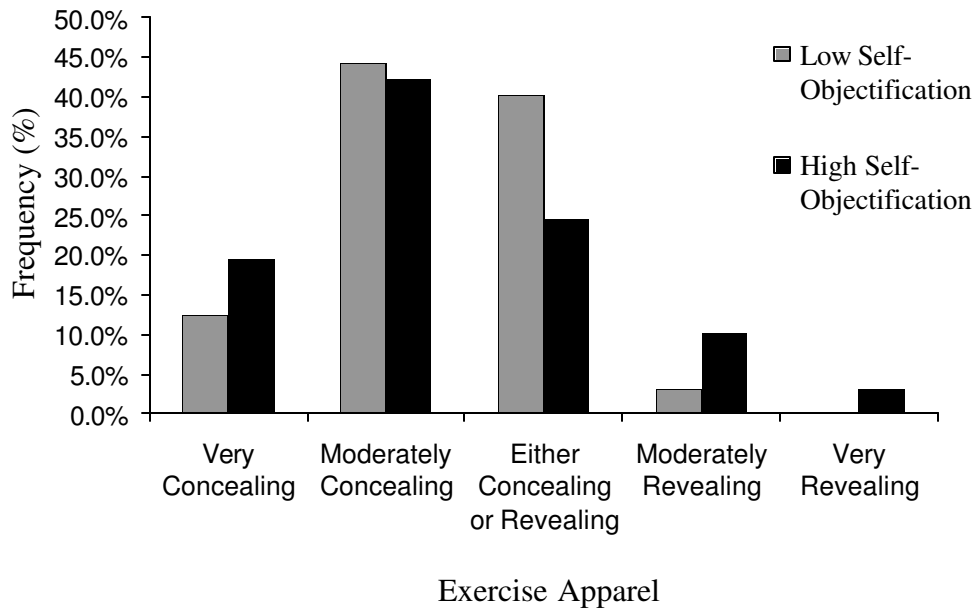

Figure 3. Bar graph of exercise apparel preference of high and low objectification groups.

Low objectification women reported wearing “either concealing or revealing equally” (40.2%) more than the high objectification group (24.7%). Women high in objectification, rather, reported wearing more “very concealing” (19.6% vs. 12.4%) and “moderately to very revealing” exercise attire than the low objectification women (13.4% vs. 3.1%). In addition, a differences were noted on location of exercise, $\chi^2 (3, N = 193) = 12.056, p = .007$; the low self-objectification women preferred the outdoors (45.4% vs. 21.9%), while the high self-objectification group rated the public facility as the most desired location (55.2% vs. 37.1%). These findings are presented in Figure 4.

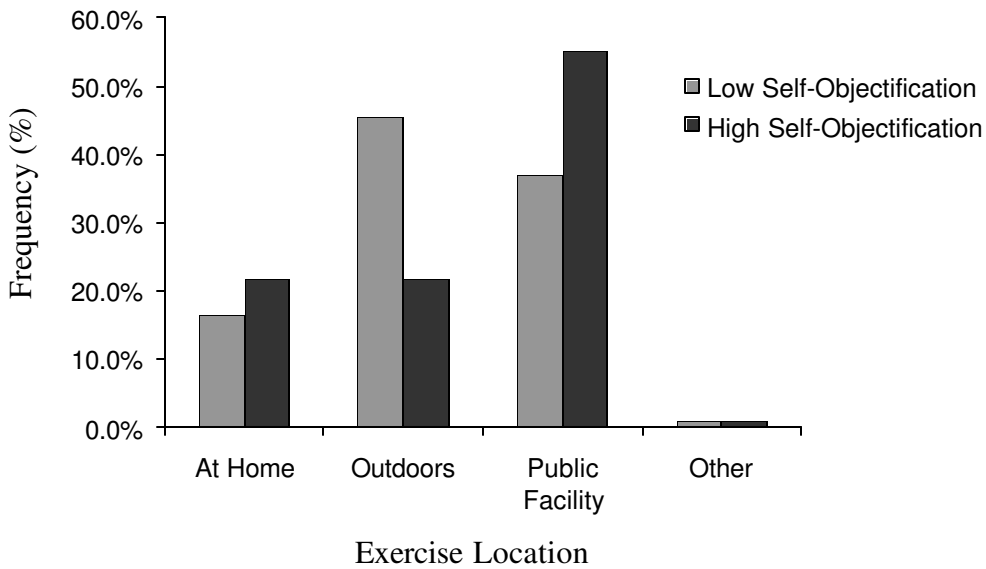

Figure 4. Bar graph of exercise location preference of high and low self-objectification women.

Although not significant, a trend for significant difference was observed on cardio machine use, $\chi^2 (1, N = 189) = 2.861, p = .091$. High self-objectification women reported more use of the aerobic equipment (61.7% vs. 49.5%) than low objectification women (see Figure 5).

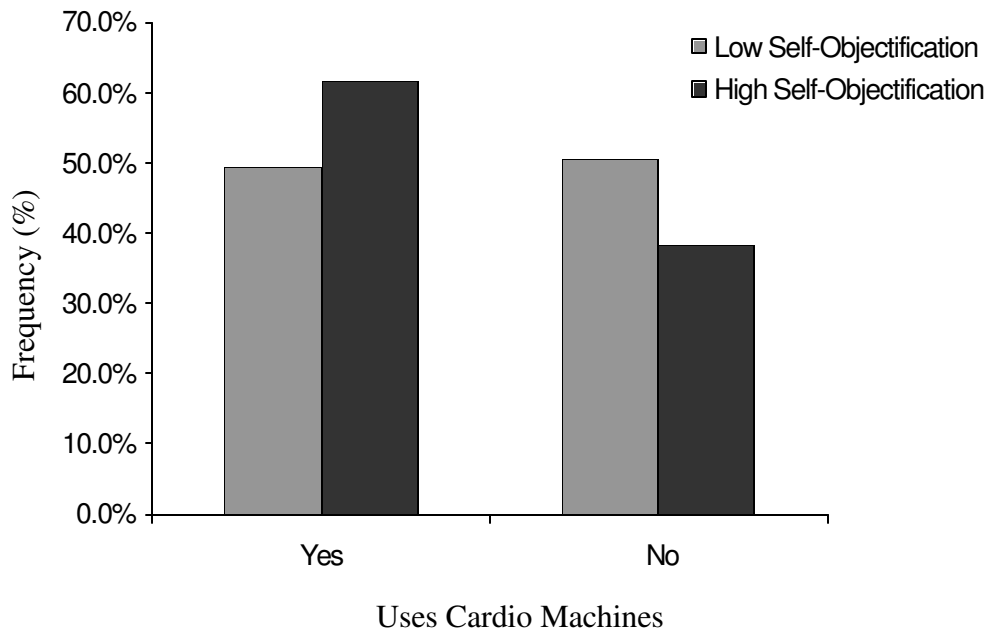

Figure 5. Cardio machine participation of high and low self-objectification women.

Non-significant differences between the high and low SOQ groups were revealed for the length of exercise workouts, χ^2 (4, N = 194), $p = .510$, exercise company, χ^2 (2, N = 191), $p = .225$, the preferred time of day to exercise, χ^2 (4, N = 174), $p = .198$, and the mode of exercise. The results of the χ^2 and ϕ -statistics are presented in Table 5.

Table 5

Pearson χ^2 and ϕ -Statistics Test of Exercise Behavior for Low and High Self-Objectification Women

Exercise Behavior	χ^2	p	ϕ	p
Frequency	10.23	.017	.230	.017
Length	3.29	.510	.130	.510
Apparel	11.97	.018	.248	.018
Company	2.98	.225	.125	.225
Location	12.06	.007	.250	.007
Time of Day	6.017	.198	.186	.198
Type of Exercise				
Weight Training	.257	.663	-.037	.612
Run/ Walk	.343	.558	.043	.558
Cardio Machines	2.861	.091	-.123	.091
Ball Sports	.622	.430	.057	.430
Yoga/ Pilates	.468	.494	-.050	.494
Swimming	.310	.577	.041	.577
Aerobic Classes	1.903	.168	-.100	.168
Karate/ Martial Arts	2.357	.125	.112	.125
Other	2.032	.154	.104	.154

Measurement Models

Three measurement models were used to evaluate the adequacy of the indicators of each latent variable. A summary of fit statistics for the measurement and structural models are presented in Table 6 including all χ^2 test information and CFI and RMSEA values. All the measurement models revealed substantial multivariate kurtosis (Mardia's Normalized Estimate between 3.28 to 11.69). To manage multivariate nonnormality, analyses producing χ^2 statistic

and standard errors were scaled using Yuan-Bentler scaled statistic (EQS 6.1) to approximate the referenced χ^2 distribution. This occurred for the robust maximum likelihood. Significant χ^2 tests were observed for all measurement models, indicating an inadequate fit of the models to the data in each instance. Other fit indices examined in the study for each model, however, suggested that the measurement models may in fact be adequate.

The first measurement model was that of the objectified body consciousness scales (OBCS) subscales of surveillance (8 indicators), and shame (7 indicators) (see Figure 6). The global fit of this model to the data was poor, $\chi^2 = 304.09$, $p < .01$, CFI = .82, RMSEA = .09. The robust estimates also indicated a poor fit of the OBCS measurement model to the data, $\chi^2 = 262.78$, $p < .01$, CFI = .84, and RMSEA = .08, respectively.

Examination of the OBCS indicator loadings, standardized residuals, and modification indices in the initial measurement analysis indicated difficulty with four items in particular. These items included: OBCS1, “Think about looks” ($\beta = .37$), OBCS4, “Comfort of clothes” ($\beta = .35$), OBCS16, “Worry about clothes” ($\beta = .44$), and OBCS20, “Control weight” ($\beta = .43$). The remaining items loading values ranged between .52 - .81, all significant at $p < .05$. Removal of these troubled items in a subsequent OBCS measurement model analysis produced more satisfactory results. A significant χ^2 was still observed, $\chi^2 = 95.41$, $p < .01$ (robust $\chi^2 = 80.73$, $p < .01$), but other indices suggested an adequate fit of the OBCS measurement model to the data, CFI = .94, RMSEA = .06 (robust CFI = .95, robust RMSEA = .05). The fit indices are presented in Table 6. The measurement model is illustrated in Figure 7.

Table 6

Measurement and Structural Model Maximum Likelihood (ML) and Robust Estimation of Fit Indices

Model	χ^2 ML/ Robust	df	CFI ML / Robust	RMSEA ML/ Robust
Meas. 1	304.09/ 262.78	89	.82/ .84	.09/ .08
Mod. Meas. 1	95.41/ 80.73	43	.94/ .95	.06/ .05
Meas. 2	41.52/ 33.90	14	.97/ .98	.08/ .07
Meas. 3	276.11/ 238.39	132	.93/ .95	.06/ .05
SEM 1	87.67/ 74.93	26	.94/ .94	.09/ .08
SEM 2	334.38/ 286.98	148	.92/ .93	.07/ .06

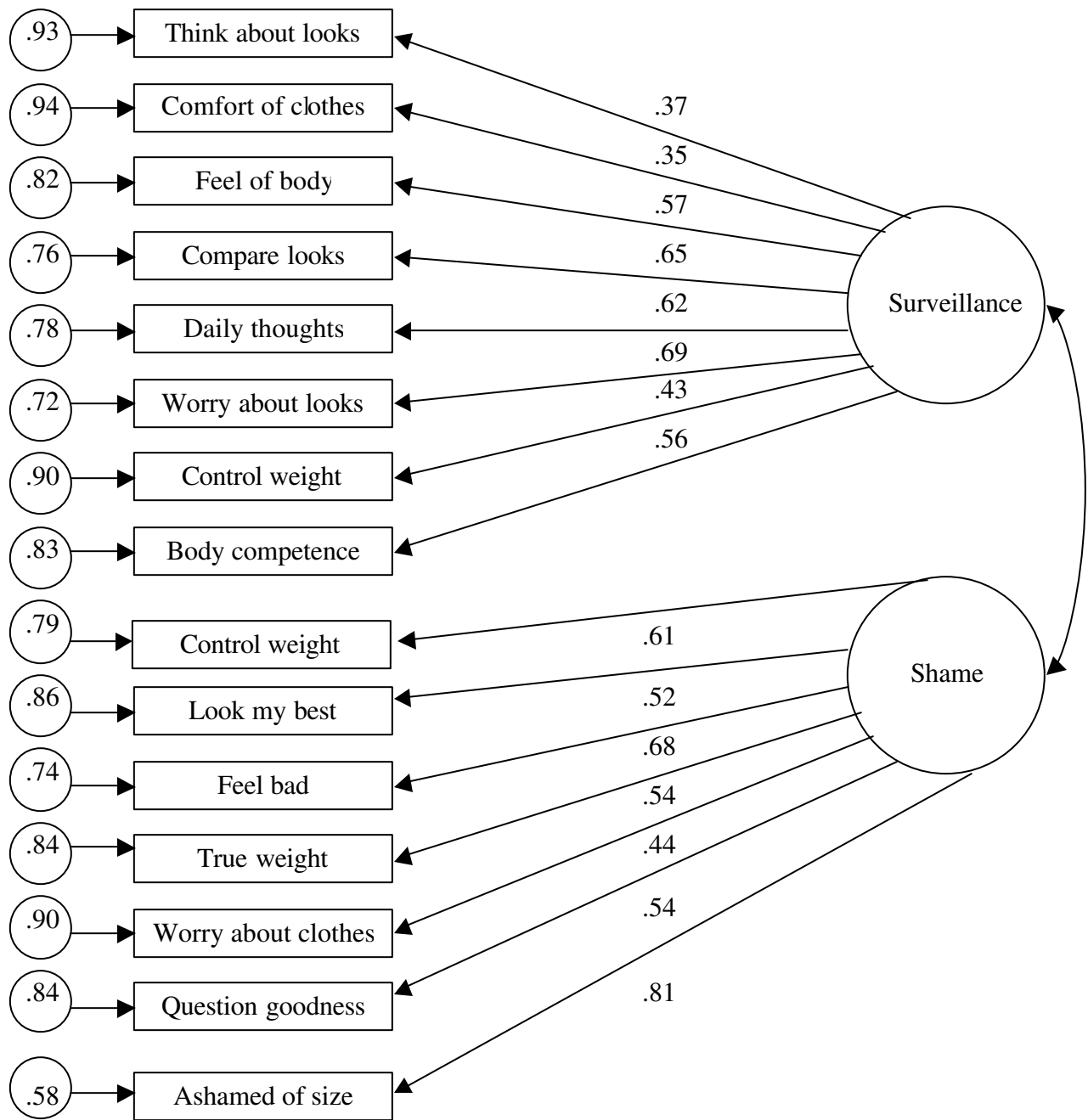

Figure 6. Measurement model of OBCS surveillance and shame subscales with 15 loading items.

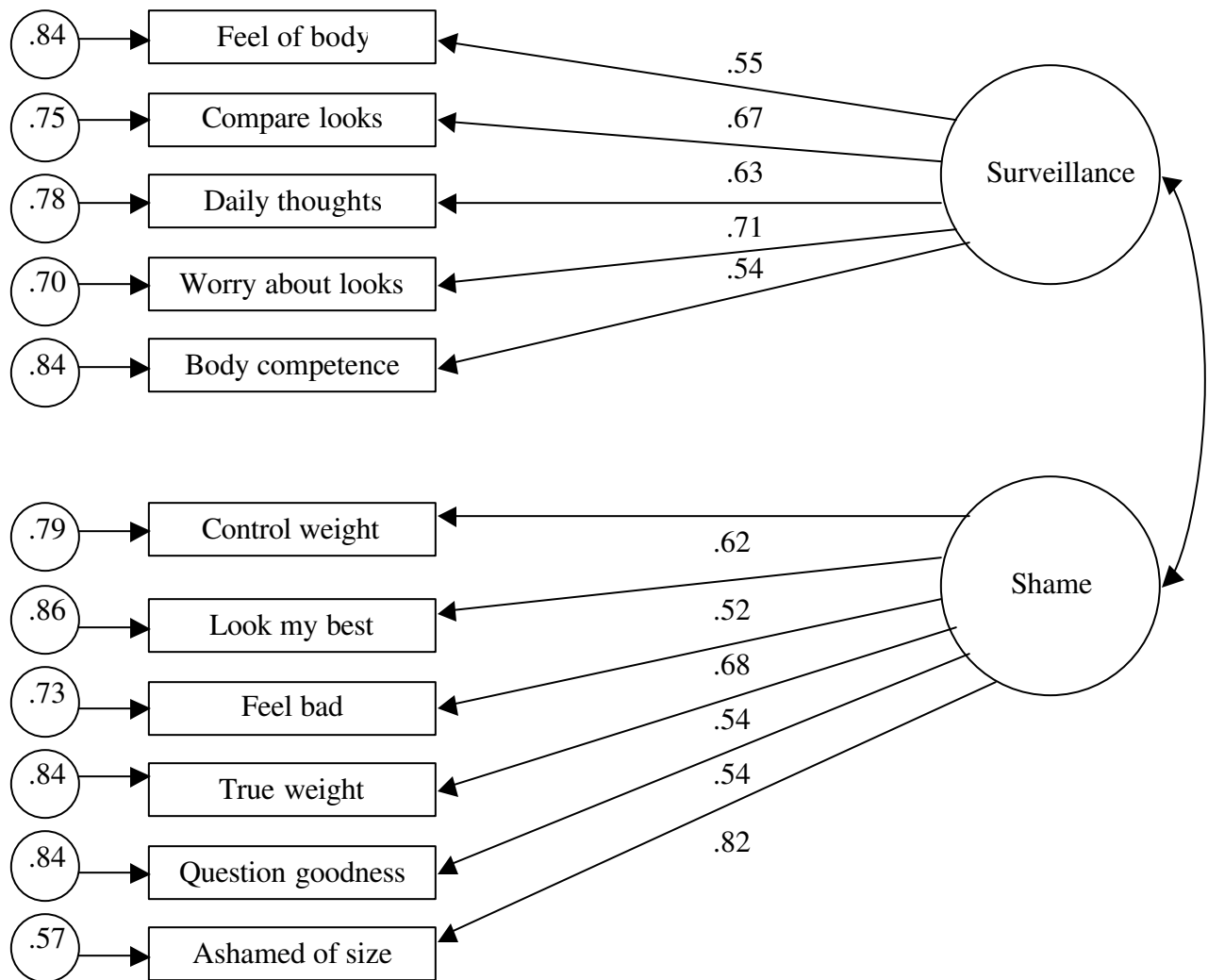

Figure 7. Modified measurement model values for surveillance and shame OBCS subscales with 11 loading items.

The second measurement model examined was that of the SPAS scale (7 indicators). The fit indices are presented in Table 6, and the measurement model is illustrated in Figure 8. The model proved to be satisfactory, with ML fit indices of CFI = .97 and RMSEA = .08. The robust indices of fit were also satisfactory, CFI = .98, and RMSEA = .07. All of the item loading values were significant and ranged between .56 - .83.

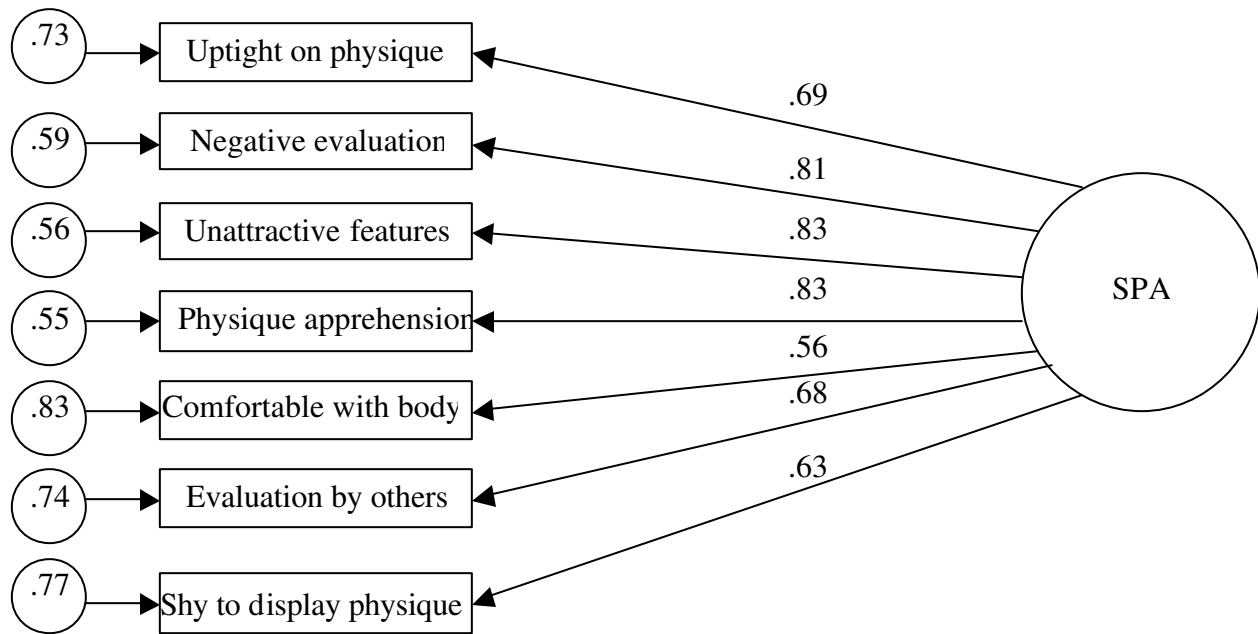

Figure 8. Measurement model values for SPAS.

The third measurement model examined was that of shame subscale (6 indicators), the surveillance subscale (5 indicators), and the SPAS (7 indicators). The fit indices are presented in Table 6, and the measurement model is illustrated in Figure 9. This model proved to be satisfactory. The ML estimates of fit were CFI = .93, and RMSEA = .06. The robust estimates of fit were CFI = .94, and RMSEA = .05. All of the value loadings ranged between .51 - .83.

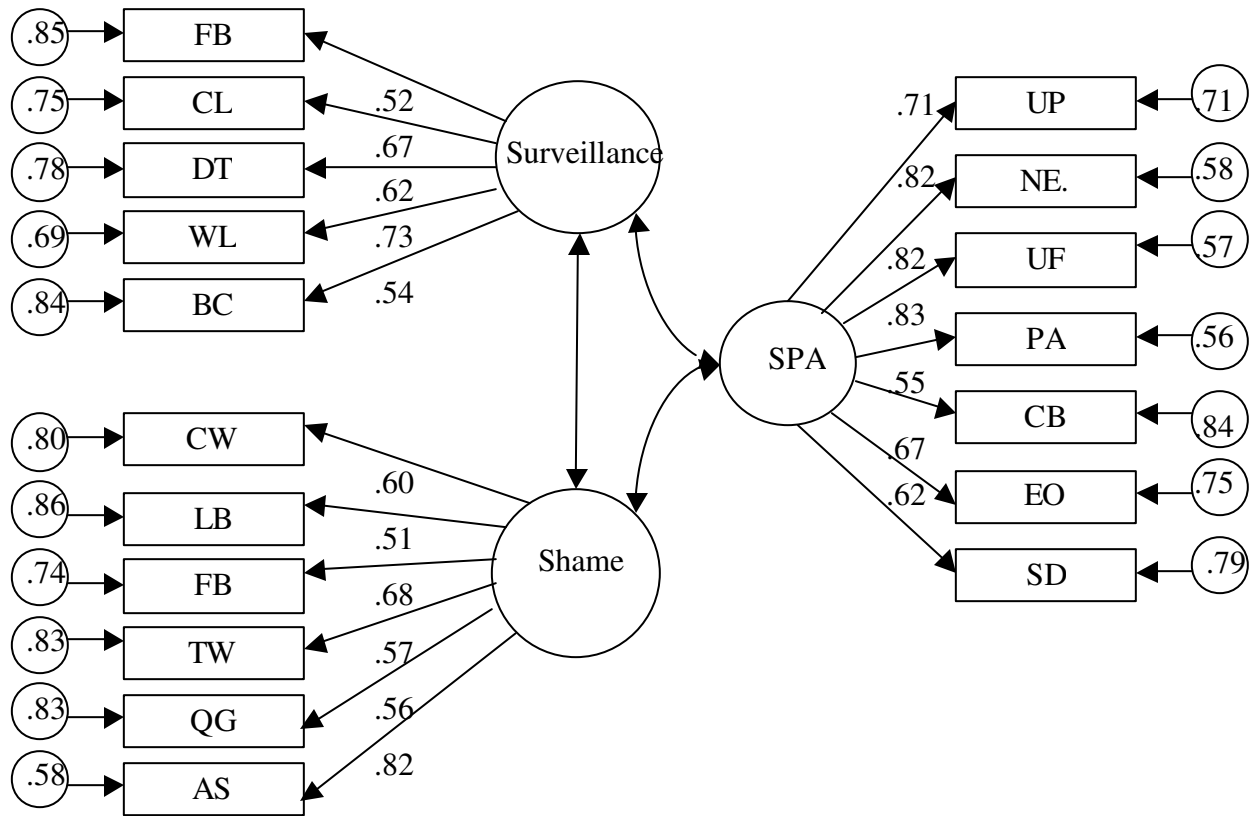

Figure 9. Measurement model for OBCS, surveillance and shame subscales, and SPAS.

Testing of the Theoretical Model

Two models were examined to test the fit of the data. In both of the structural equation models (SEM), the χ^2 indicated a poor fit to the data. Further examination of the other fit indices of CFI and RMSEA supported the models otherwise.

The first model included the SOQ, the SPAS and Protective/Permissive exercise behavior. The theoretical model proposed that self-objectification (SOQ) would impact protective/permissive exercise behavior both directly and indirectly via SPA. Testing of the model proved to be “almost” satisfactory. The ML and robust estimations of fit are presented in Table 6, and structural model appears in Figure 10. The ML estimates of fit were CFI = .94, and RMSEA = .09. The robust estimates of fit were CFI = .94, and RMSEA = .08. The regression path from self-objectification to SPA was $\beta = .382, p \leq .05$. This indicates that self-objectification has a causal path with SPA in the expected direction, i.e., the greater the self-objectification, the more a person experiences SPA. Against expectations, however, self-objectification does not appear to have predictive power of protective/permissive exercise

behaviors, $\beta = -.089$, nor does SPA, $\beta = .074$. This indicates that SPA does not mediate between self-objectification and exercise behaviors.

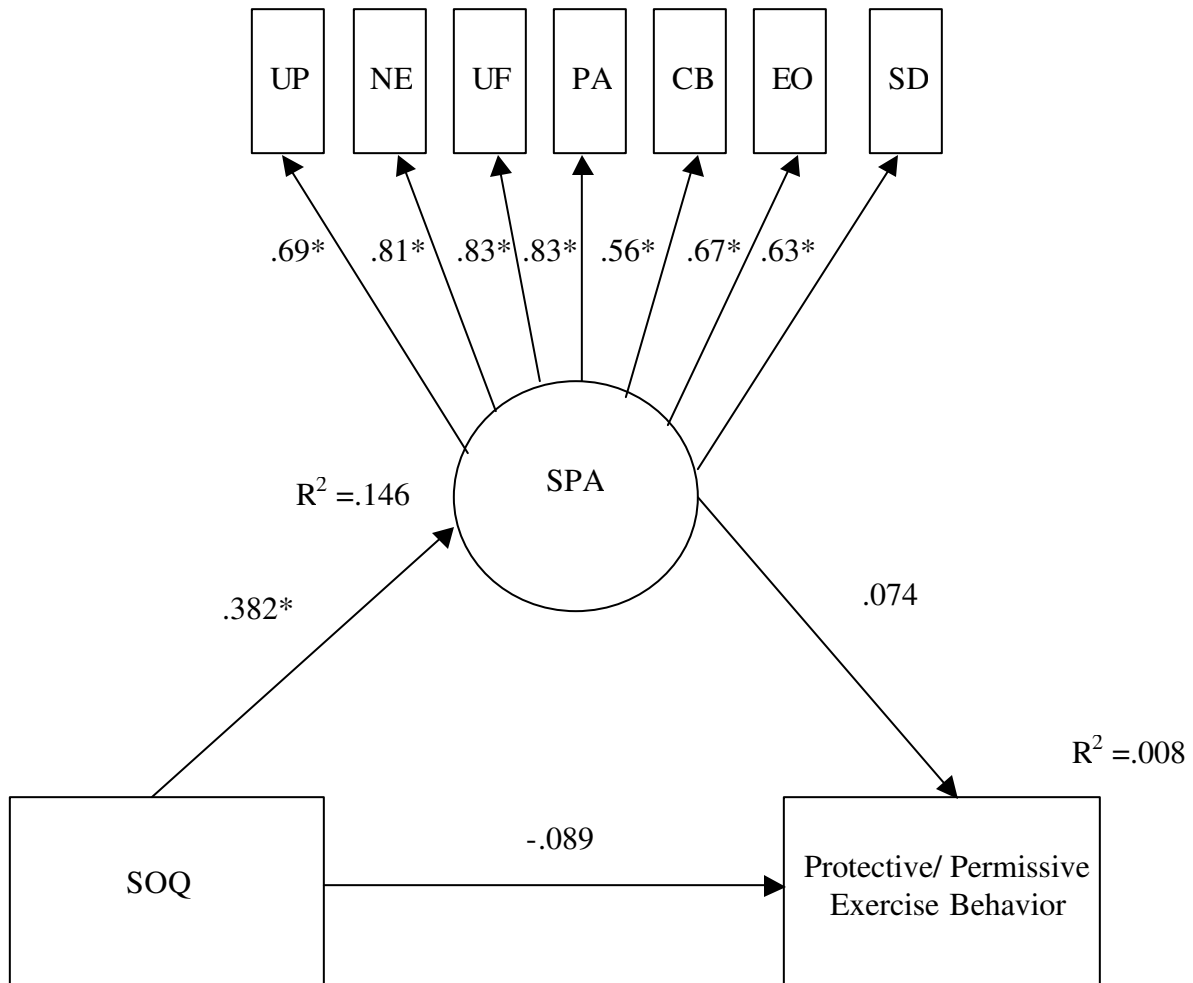

Figure 10. First model proposed with standardized regression values, loadings, and R^2 values ($p \leq .05$).

Testing of the second model fit, OBCS, the shame and surveillance subscales, SPA and Protective/Permissive exercise behavior, also proved to be satisfactory. ML and robust estimations of fit are presented in Table 6, and the structural model appears in Figure 11. The ML estimate of fit indices were CFI = .92, and RMSEA = .07. The robust estimates of fit were CFI = .93, and RMSEA = .06. The regression paths between OBCS to surveillance was $\beta = .76$, $p \leq .05$, from OBCS to shame, $\beta = .87$, $p \leq .05$, and OBCS to SPA, $\beta = .94$, $p \leq .05$. This indicates that the OBCS which comprises surveillance and shame, has a causal path to SPA in the expected direction. For instance, the greater a person's objectified body consciousness, the

higher their SPA. Against expectations, OBCS did not have any predictive power on permissive/protective exercise behaviors, $\beta = -.69$, nor does SPA, $\beta = .69$. This indicates that SPA does not have a mediating role between OBCS and protective permissive exercise behavior. The minor accounted variance despite the large regression coefficients may be partly due to the extremely large error value (.97), permitting no more than 5% accounted variance. Also, the poor correlations between the SPA, OBCS subscales and the protective/permissive exercise behavior measure lends further insight for the lack of accounted variance by OBCS and SPA. The correlation values ranged between $-.10$ to $.01$ (See Table 4).

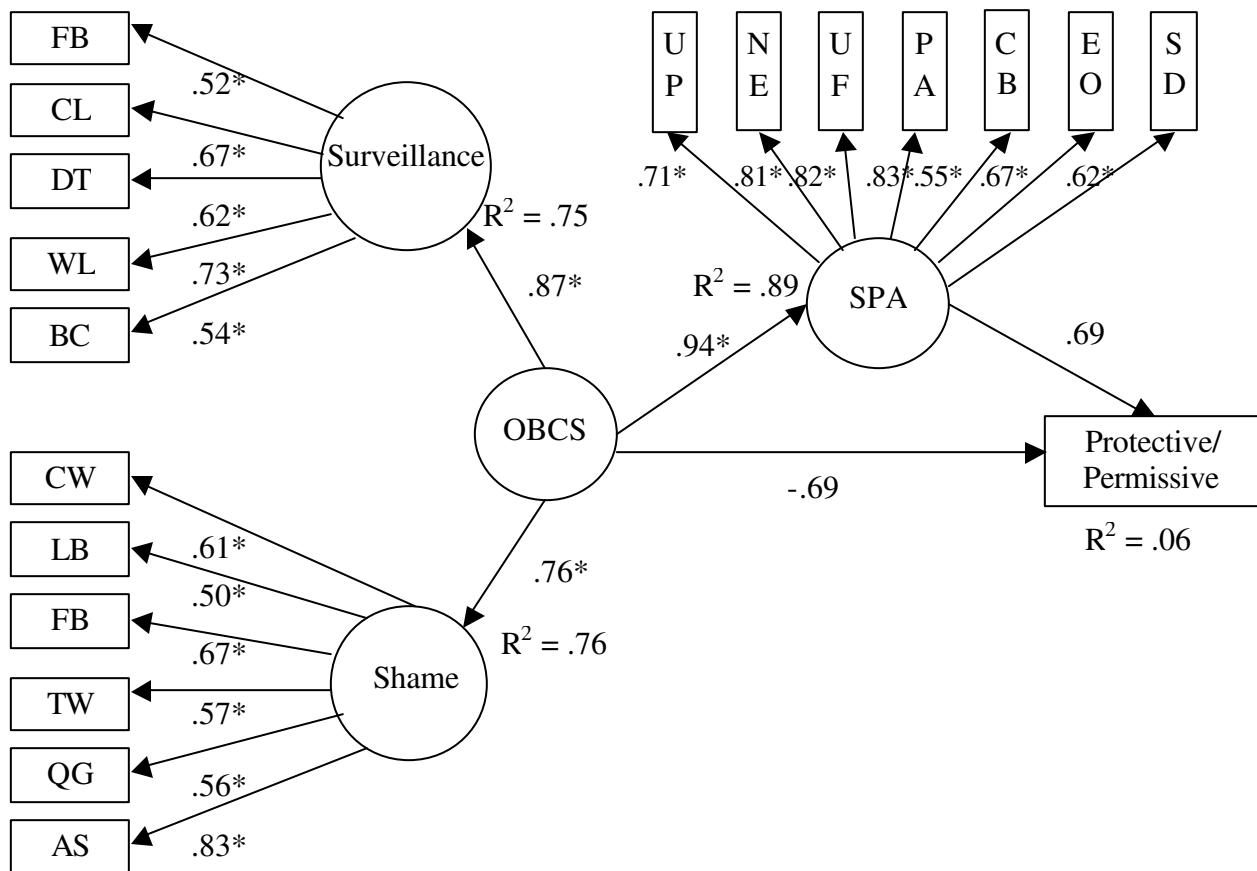

Figure 11. Second model proposed with standardized regression values, loadings, and R^2 values (* $p \leq .05$).

Age and Self-objectification

To test the fourth hypothesis that younger women have higher self-objectification than older women, a one-way ANOVA was performed using the three age groups (18-24, 25-34, and

> 35) as the independent variable, and SOQ and the OBCS subscales of Shame and Surveillance as the dependent variables. The means and SDs for each of these age groups' SOQ and OBCS subscales are presented in Table 7.

Table 7

Mean scores for each age group on SOQ and OBCS Subscales

Scale	Group	n	M	SD
Surveillance	18-24	140	4.35	1.02
	25-34	78	4.21	1.15
	> 35	73	3.73	0.96
Shame	18-24	140	3.45	1.95.27
	25-34	78	3.29	1.24
	> 35	73	3.22	1.14
Control	18-24	140	4.98	0.99
	25-34	78	5.25	0.95
	> 35	73	5.09	1.08
SOQ	18-24	140	-1.64	12.13
	25-34	78	-6.77	12.51
	> 35	73	-9.19	12.20

Significant differences among the age groups were obtained for the SOQ, $F(2, 288) = 10.35$, $p < .001$, and the surveillance subscale, $F(2, 288) = 9.36$, $p < .001$. The shame subscale did not result in significant difference, $F(2, 288) = .93$, $p = .40$. Tukey HSD post-hocs were performed on the SOQ and OBCS Surveillance subscale to further determine the differences between the age groups. Results are presented in Table 8.

Table 8

Tukey HSD Post-hoc paired comparisons of Self-Objectification Questionnaire (SOQ) and Objectified Body Consciousness Scales (OBCS) Surveillance Subscale among age groups

Scale	Age Groups		Mean Difference	SE	p
SOQ	18-24	25-34	5.13	1.73	.009*
		> 35	7.55	1.77	.000*
	25-34	> 35	2.42	1.99	.445
Surveillance	18-24	25-34	.14	.15	.613
		> 35	.62	.15	.000*
	25-34	> 35	.48	.17	.014*

The Tukey HSD post-hoc tests indicated that women 18-24 and 25-34 years reported greater surveillance than women 35 years and older. No difference was observed between the women of 18-24 and 25-35. Furthermore, women 18-24 years of age scored higher on the SOQ, indicating that the younger women objectified their bodies more, whereas the women 25-34 or 35 years and older, whose scores were lower on the SOQ, viewed their body's more for its' competence. No difference was noted between women 25-34 or 35 years and older. This indicates the younger women self-objectify more than older women, supporting the fourth hypothesis.

CHAPTER V: DISCUSSION

The purpose of this study was to examine the role of self-objectification on exercise behavior, and also to determine if SPA had a mediating role between self-objectification and exercise behaviors. Self-objectification theory (Fredrickson & Roberts, 1997) postulates that people internalize the sexual objectification of the body by the external cultural to varying degrees. As a result, a value is placed upon the body, highly impacting a person's self-perception. Further, a person who is said to objectify will commonly start to view their bodies through an external lens, as if it were an item on display. The intense focus on the body and emphasis of other's perception of it extends to another variable investigated in this study, social physique anxiety (SPA). SPA is a form of anxiety that a person experiences when they feel that others are potentially viewing their body in a negative light (Hart, Leary, & Rejeski, 1989). The final variable included within this study was exercise behavior, a person's typical pattern of fitness activity participation. It was further separated within the present study into two classifications of protective or permissive. Protective behavior was defined as an act that involved the person attempting to regulate their appearance and presentation of it to others. Permissive behavior, on the other hand, was less controlling and concerned with exposure of the physique around others.

The current study proposed that self-objectification and SPA would be positively related. Self-objectification has been observed in previous research to share a positive relationship with appearance anxiety (Roberts & Gettman, 2004; Slater & Tiggemann, 2002). SPA and self-objectification combined have received relatively little attention in research, but a positive relationship has been noted (Calogero, 2004). Since self-objectification involves a high preoccupation with appearance and a heavy importance placed on the display of the body, it is logical to assume that a person highly objectified would also be more anxious that others might observe their body in a negative light.

It was also proposed that a person's objectification level would relate to their exercise behaviors, both directly and indirectly via SPA. SPA and certain exercise behaviors have been noted, including exercise adherence, desired exercise environment, and reasons for exercise. Most exercise behaviors that were observed indicated a preference towards garnering less attention, especially regarding the physique (Brewer, Diehl, Cornelius, Joshua, & Van Raalte, 2004; Crawford & Eklund, 1994; Eklund & Crawford, 1994; Finkenber, DiNucci, McCune,

Chenette & McCoy, 1998; Fredrickson & Morrison, 1996; Lantz, Hardy, & Ainsworth, 1997; Spink, 1992). Self-objectification and exercise research, however, is relatively limited. As observed for SPA, women higher in self-objectification typically reported exercising for more appearance-related reasons as opposed to health-based motives (Strelan, Mehaffy, & Tiggeman, 2003). The final concern of the current study was to determine if self-objectification is higher among younger women than older women. Despite the fact that body satisfaction remains relatively stable regardless of age throughout a person's life, self-objectification has been found to diminish with age, starting somewhere in a women's 40's (Greenleaf, 2005; Slater & Tiggemann, 2002; Tiggemann & Lynch, 2001).

The participants in the current study were limited to being female, as self-objectification and SPA have both been noted to be more prevalent for women than men (Haase, Prapavessis, & Owens, 2002; Hart, Leary, & Rejeski, 1989; Miner-Rubino, Twenge & Fredrickson, 2002). The women were gathered from several locations around town, including dog parks, the public library, the airport, a local mall, parks, and the local University. All participants were at least 18 years of age. The study revealed a positive relationship between self-objectification and SPA, as well a decrease in objectification with age. Support for the proposed models was obtained, and a difference in the exercise behaviors of women high and low in objectification was observed on their exercise behaviors of adherence, apparel, preferred location. A trend was noted for a difference in cardio machine participation between women high and low in objectification.

The first hypothesis of this study predicted a positive relationship between self-objectification and SPA. In line with previous research (Calogero, 2004), a moderate positive relationship was observed between the SOQ and the SPAS. Women high in self-objectification (i.e., viewing themselves through an external lens or as if they were an object), also tended to report higher levels of SPA. Since appearance anxiety is a commonly associated behavior of self-objectification (Roberts & Gettman, 2004; Slater & Tiggemann, 2002), it is obvious that the heightened anxiety would extend more to an area regarding a person's physique. Also, self-objectification is associated with higher levels of body shame and body disgust (Fredrickson, Roberts, Noll, Quinn & Twenge, 1998; Miner-Rubino, Twenge & Fredrickson, 2002; Roberts & Gettman, 2004). In addition to having elevated objectification and being less accepting of their body, it seems quite fathomable that these women would also experience more anxiety regarding their physique, especially when it involves the potential that others might be viewing their bodies

in negative light. Physical appearance is extremely important to a person high in objectification (Fredrickson & Roberts, 1997). When self-worth and happiness is derived from their physical appearance, it seems plausible that it would be very important for others to be viewing their body positively. When a woman who is high in objectification is potentially having her body evaluated in a less than positive manner, the extra pressure and emphasis placed on her body may result in her becoming more anxious, since her body's appearance is so important to her self-perception.

The second hypothesis tested the notion that women high in objectification would exhibit different exercise behaviors than those low in objectification. In particular, it was predicted that women high in objectification would partake in more protective behaviors when exercising, including exercising in private locations, being an extremely high or low in exercise adherer, exercising alone, wearing baggier clothing, preferring to exercise at off-peak hours, and would participate in more body-oriented exercises. Those high in objectification would be more permissive and report the opposite behavior. This would include moderate exercise adherence, exercising more in public situations, more likely to wear revealing clothing, exercising during peak hours, and participating more in the mind-body exercises. Findings regarding the exercise behaviors of women high and low in self-objectification were mixed, and at times different than what was predicted.

Women high in self-objectification in the current study reported low exercise adherence, with majority of the women participating two times a week or less. Women low in self-objectification, rather, had greater weekly exercise participation. This may be an extremely protective behavior of women high in objectification to avoid the exercise situation completely, a trend that is partially noted in the SPA relationship with exercise. Research on SPA (Finkenber, DiNucci, McCune, Chenette & McCoy, 1998; Frederickson & Morrison, 1996; Lantz, Hardy, & Ainsworth, 1997) has observed an extremely high or extremely low adherence of people high in SPA. Avoidance of the situation, such as an increased state of objectification or the potential of a gaze, may play a role as to why women high in objectification may avoid working out. Further, exercise can create a situation of where the person may appear less composed (i.e., sweating, flushing of the skin), and likewise may be socially considered less presentable. Appearing attractive and respectable is extremely important to women high in objectification (Fredrickson & Roberts, 1997). It may be possible that avoidance or a low

participation in exercise is a preventative action from exposure. In order to avoid externally viewing and observing themselves in a more 'unkempt' state, thereby being considered less socially desirable, women high in objectification prevent this possibility by avoiding exercise.

Another behavior difference between women high and low in self-objectification was exercise apparel. The exercise apparel mainly reported by women high in self-objectification was more concealing, however, they also reported wearing revealing clothing more so than women low in self-objectification. The behavior, however, was unexpected in that the women high in objectification reported wearing more revealing clothing than the women low in objectification. Women that were low in objectification reported that they wore "either revealing or concealing clothing equally" the most, with a slight leaning towards a greater report of concealing clothing among the rest of the respondents. Eklund and Crawford (1994) did note a positive correlation between SPA and an exercise attire preference for more concealing clothing, however, they were unable to substantiate their findings through repeated-measures regressions. Perhaps the preference or selection of exercise attire may be more contingent upon the environmental setting or the social situations of where the exercise takes place rather than being a direct result of the person's degree of objectification. It has been established that tighter clothing induces higher levels of objectification, where heightened levels of body awareness and surveillance are a reaction to the restricting clothing (Fredrickson, Roberts, Noll, Quinn, & Twenge, 1998; Miner-Rubino, Twenge, & Fredrickson, 2002). It is possible the selection of clothing, in particular concealing or protective items, is a preventative measure employed by those high in SPA that is dependent on more variables, especially the environment of the chosen exercise location, rather than a constant selection of the particular attire.

The most preferred exercise locale of women high in objectification was the local gym or public facility, while outdoors was the most desired for women low in objectification. Although it was predicted that exercising in a private location, such as at home, where the person would be able to limit their exposure and potential gazing by others, there are some possible explanations for why the gym was the desired location. First, a person high in objectification may chose an exercise location such as the gym as they may be able to find a spot that is relatively hidden. For instance, they may participate in aerobic classes, but remain in the back, a noted behavior for women with higher levels of SPA (Brewer, Diehl, Cornelius, Joshua & Van Raalte, 2004), or choose equipment that is less in the forefront. Exercising outdoors, the most common choice for

low objectification women, may be situation where there is potentially more of a chance of display. For instance, if a person exercises at a crowded park or runs along a busy street, this is a situation where the person may be considered to be on greater display. Another factor to consider when viewing the results is that it was not stated whether the gym or public facility was coed or a women only gym, which may alter the findings. Walton and Finkenberg (2002) observed that a woman's SPA levels were related to their gym selection, with women higher in SPA having a preference for the women-only exercise facilities. This may also play a role for self-objectification, in that the greater report of preferring exercising at a public facility may be partially contingent upon the sexes attending that location. More research is needed to determine preferred exercise location of people, with particular regard to objectification levels.

Finally, a trend was observed towards greater cardio machine participation by women high in objectification compared to women low in objectification. Cardio machines are a body-oriented exercise, where the focus is more at burning calories and toning the body, as opposed to creating awareness of the body and mind, such as experienced in activities including yoga or martial arts. Daubenmier (2002) found Hatha yoga participants to have lower self-objectification levels than participants of the body-oriented exercise of aerobics. Although a difference of participation was not noted between women high and low in objectification on yoga, potentially this effect may be indicative of the trend that was observed in the participation levels of cardio machines. That is, women higher in objectification were more attracted to participate in the body-oriented exercise of cardio machines than were women low in objectification.

Despite a trend being observed for a difference between high and low objectification on cardio machine participation, no differences were noted on any of the other forms of exercise (running/walking, weight training, swimming, ball sports, yoga/ pilates, martial arts, aerobic classes, other activities). Further, no difference was observed on the conditions of exercise duration, exercise company, or preferred time of day to exercise. Participation in exercise was found to be lower among women high in objectification, with a greater majority reporting no exercise at all than women low in objectification. If a person is not exercising, then their reported length of exercise workouts may be arbitrary, thereby creating poor results and a low chance to find a difference.

Exercise company, the people that a person chooses to exercise with or not, also failed to differentiate in preference between women high and low in objectification. The preference for

exercising either alone or with friends over exercising in a group setting, which may not include friends, was equally reported between the two groups. Carron and Prapavessis (1997) investigated social anxiety of participants exercising in a group setting either alone or with friends. They observed that social anxiety diminished most for the participants when they were accompanied by a best friend or a group of friends to the group workouts. This may be the reason for the greater preference for exercising with friends, and perhaps those who desired to exercise alone avoided the group situation altogether.

The time of day women preferred to exercise was not found to be different, potentially due to the confounding variable of desired exercise location. The same time of day may have different implications regarding crowds and potential for observations by others. For instance, exercising at home in the evening would have different behavior implications than working out at a popular public facility, yet the hours of participation are the same. Further, people may not have a preferred time of day to exercise, but only can consider times that they may have the availability to exercise as an option.

An additional aim of the current study was to test the proposed model, which postulated that SPA had a mediating role between self-objectification and exercise behavior. Self-objectification has been shown to be positively associated with SPA (Calogero, 2004), and has been shown to be related to more appearance and body oriented motives for exercise (Daubenmier, 2002; Strelan, Mehaffy, & Tiggeman, 2003). Further, SPA has been related to exercise behaviors that typically attempt to distract or avoid attention to their physique (Brewer, Diehl, Cornelius, Joshua, & Van Raalte, 2004; Crawford & Eklund, 1994; Fredrickson & Morrison, 1996; Spink, 1992). The models developed proposed that a person high in self-objectification would have strongly internalized the cultural ideals and thus begun to carefully monitor their appearance, frequently via an external lens. Due to the heightened pressure on their appearance, a person high in objectification would likewise experience greater appearance anxiety, particularly surrounding their physique and the observation of it by others. With the increased concern surrounding their physique's appearance and presentation of it to others preoccupying their cognitive resources (Fredrickson, Roberts, Noll, Quinn and Twenge, 1998), their constant focus on their appearance would result in heightened anxiety, especially SPA. Finally, it was proposed that certain exercise behaviors would be considered to be either more protective or permissive in their nature. Seeing as those who were higher in objectification and

SPA would be more concerned with their physical appearance and that others may not be viewing it favorably, it was predicted that more protective exercise behaviors would occur. That is, for instance, people high in objectification would be worried about their physique's appearance, and in turn would choose to exercise in private locations, alone or in baggier clothing in order to 'protect' themselves. Those lower in objectification, and SPA as well, would be less concerned and more permissive in their behavior, including exercise in revealing clothing, in public locations and among people they are not necessarily friends with.

The first SEM model tested, proposing self-objectification influenced protective/permissive exercise behavior both directly and indirectly via SPA, was supported overall. Interestingly, however, the only path significant was that from self-objectification to SPA. This indicates that self-objectification is associated with and probably impacts SPA, with women high in objectification also being high in SPA, or vice versa. The extra attention placed on the body by those high in objectification results in a preoccupation with their appearance. This preoccupation with their physique and the external monitoring of it is conducive to the development of increased anxiety, especially regarding the body and the fact that it may not appear like the cultural ideal to others.

Unfortunately, however, the predicted causal flow from self-objectification to protective exercise behaviors was not supported, nor via the route through SPA. Although it was hypothesized that people who are higher in objectification, and likewise SPA, would participate in different exercise behaviors than those lower, the SEM model indicates otherwise. As Eklund and Crawford (1994) mentioned, it is difficult to predict a person's exercise behavior as many factors may play into each session's behavior. As in the case of this study, each protective or permissive exercise behavior may be influenced by many other variables surrounding the exercise experience. For instance, where a person may be heading to workout may alter what apparel they choose to wear, with different activities, temperatures or locations lending themselves to be more conducive to either more revealing or concealing clothing. Another situation may be that the company they choose to surround themselves with when working out may be relevant to where they are deciding to workout, rather than it be solely a result of either a protective or permissive behavior. Although the influence of self-objectification, objectified body consciousness or SPA on exercise behavior struggled to find support, the models still

helped to illustrate some of the connections and reasoning between objectification and objectified body consciousness on SPA.

The second SEM model, proposing objectified body consciousness influenced protective/permissive exercise behavior both directly and indirectly via SPA, was supported. The SEM model found support for objectified body consciousness influencing SPA. This would suggest that people who were higher in body surveillance and body shame, thereby greater in overall objectified body consciousness, were also higher in their SPA. This relation is apparent because people who are constantly vigilant about their bodies and ashamed of its' appearance would also become more anxious in social situations where others have the potential of viewing their body negatively. Interestingly, protective/ permissive exercise behavior could not be predicted. Again, as discussed previously, a consistent ability to predict a person's exercise behavior may be difficult due to the many extenuating circumstances comprising a person's action. Unfortunately, support for the mediating role of SPA was not found.

The study also examined self-objectification in different ages. Self-objectification was found to be higher among the younger women, supporting previous findings (Greenleaf, 2005; Slater & Tiggemann, 2002; Tiggemann & Lynch, 2001). Women 35 and older were observed to have lower objectification compared to the younger women, those 18-24 and 25-34 year olds. Interestingly, it did not appear that self-objectification differed greatly between the two younger groups. Societal pressures to appear a certain way may ease with age, possibly explaining for the decrease observed in the 35 and older age group. In previous research, Tiggemann and Lynch (2001) noted young women in their 20's and 30's to be the highest in objectification, with a decline beginning when women reach their 40's and 50's, with an even greater decline after the age of 60. This study noted a decrease in objectification levels of women beginning as young as 35 years of age. The lower preoccupation with the body and its' appearance has been noted with decreased appearance anxiety and surveillance (Dion, Dion, & Keelan, 1990; McAuley, Bane, Rudolph, & Lox, 1995; McKinley, 1999). The pressure from society to appear like the ideal may lessen with age, and it is also possible that women who are older may be more established in their lives. They may gain their value and pride from areas of their lives that younger women have not yet had the chance to create and experience.

Potential Limitations and Future Research

The questionnaires employed within this study, particularly the Exercise Behavior Survey (EBS) and Self-Objectification Questionnaire (SOQ), may have limited the findings in this study. The EBS may not have offered all the potential options regarding exercise situations, restricting answer from the participants, or forcing answers from the participants that may not have been accurate. Also, the participants were asked to indicate which one answer best described their exercise behavior for a particular situation, when in fact more than one answer may have best suited the person. A better instrument to measure how people exercise, not only their adherence levels, would be extremely advantageous.

The SOQ is only a rank-item index, and not an actual measure of the behavior. Although the OBCS was utilized to strengthen the findings of the SOQ, it would be interesting to investigate these topics with a questionnaire that specifically measures the behavior of objectification as opposed to one that categorized it. Further, there are only 10-items, 5 that are considered to be objectification oriented, and 5 that are competence based. Inclusion of more items, or further testing to determine if subjects agreed with the classification of the descriptors may have been beneficial.

Another potential limitation of the study was that women high in objectification did not fall as strongly on the objectification part of the scale as did the women low in objectification on the body competence end of the spectrum ($M = 9.69, SD = 6.89$ vs. $M = -18.59, SD = 4.20$). Though some differences were found between the two groups regarding their exercise behaviors, potentially if women who were even more extreme on the objectification end of the spectrum might produce exercise behavior differences that were not observed within the present study. Although all women did fall on the objectification end of the spectrum, and were able to be considered heightened in the behavior, it would be interesting to note if other differences would be observed.

Self-objectification has only recently begun to be applied to the exercise domain. This study enables the exploration of the potential effect self-objectification may have in the exercise domain. Future research should explore in greater depth the relationship self-objectification may have with exercise, such as determining if participants in aesthetically based sports and activities have higher levels of objectification than participants in competence-based ones. Further, it would be interesting to determine if a person's objectification levels may decrease with exercise,

in particular comparing a body-oriented and a mind-oriented exercise mode. Research should also investigate the relationship regarding the recent emergence of women-only gyms. It would be interesting to determine if self-objectification plays a role in the selection process of a women-only or coed exercise facility, or if the participants in the respective gyms differed in their objectification levels. Also, it would be interesting for research to potentially look into the thought processes of people low and high in self-objectification may go through when about to or are in the process of exercising. Finally, research has been mainly focused on women and self-objectification in North America, but should also consider investigating the occurrence within men and other cultures and regions around the world. The present study has succeeded in further opening the doors for future research of the role of self-objectification, in particular within the exercise realm.

APPENDIX A
DEFENSE ANNOUNCEMENT

Thesis

Treatise

Dissertation (please circle one)

Name: Lise Melbye Phone #: 850-766-0949

Department: Educational Psychology and Learning Systems

Major Professor: Gershon Tenenbaum

Defense Day Wednesday Date June 15th, 2005 Time 1:30-3:30

Location (room and building) Room 310, Stone Building

Title: Self-Objectification and Exercise Behaviors: The Mediating Role of Social Physique Anxiety.

APPENDIX B
HUMAN SUBJECTS APPROVAL



Office of the Vice President For Research
Human Subjects Committee
Tallahassee, Florida 32306-2763
(850) 644-8673 · FAX (850) 644-4392

APPROVAL MEMORANDUM

Date: 1/21/2005

To:
Lise Melbye
1327 High Rd. APT Q-6
Tallahassee, FL 32304

Dept.: EDUCATIONAL PSYCHOLOGY AND LEARNING SYSTEMS

From: John Tomkowiak, Chair

A handwritten signature in black ink that reads "John Tomkowiak, M.D.".

Re: Use of Human Subjects in Research
Self-Objectification and Exercise Behaviors: The Mediating Role of Social Physique
Anxiety

The forms that you submitted to this office in regard to the use of human subjects in the proposal referenced above have been reviewed by the Secretary, the Chair, and two members of the Human Subjects Committee. Your project is determined to be Exempt per 45 CFR § 46.101(b) 2 and has been approved by an accelerated review process.

The Human Subjects Committee has not evaluated your proposal for scientific merit, except to weigh the risk to the human participants and the aspects of the proposal related to potential risk and benefit. This approval does not replace any departmental or other approvals, which may be required.

If the project has not been completed by 1/19/2006 you must request renewed approval for continuation of the project.

You are advised that any change in protocol in this project must be approved by resubmission of the project to the Committee for approval. Also, the principal investigator must promptly report, in writing, any unexpected problems causing risks to research subjects or others.

By copy of this memorandum, the chairman of your department and/or your major professor is reminded that he/she is responsible for being informed concerning research projects involving human subjects in the department, and should review protocols of such investigations as often as needed to insure that the project is being conducted in compliance with our institution and with DHHS regulations.

This institution has an Assurance on file with the Office for Protection from Research Risks. The Assurance Number is IRB00000446.

Cc: Gershon Tenenbaum
HSC No. 2004.818

APPENDIX C

INFORMED CONSENT

I, _____, do freely and voluntarily without element of force or coercion, consent to be a participant entitled “Self-Objectification and Exercise Behaviors: The Mediating Role of Social Physique Anxiety.”

The research is being conducted by Lise Melbye, who is a Master’s Student in Sport Psychology at Florida State University. I understand her research is intended to better understand the relationship between self-objectification, social physique anxiety and exercise behaviors. I understand that I will be asked questions relating to the topics of self-objectification, social physique anxiety and exercise behaviors.

I understand that I will be completing pencil and paper questionnaires. The time to complete the surveys should be around 10-25 minutes. I understand participation is completely voluntary and I have the right to discontinue at any moment if I so choose.

I understand that all of my answers will be kept confidential, to the extent allowed by law. I understand that no individual findings will be reported, but only group findings.

I understand that I will be at minimal risk to harm during this study. If at any time I experience any emotional discomfort with the topics involved in the study, I may freely discontinue participation.

I understand the benefits of participating in this study in lending insight into the impact of self-objectification and social physique anxiety on exercise behaviors.

I understand that I may withdraw at any time without experiencing any penalty. I have been given the right to ask and have answered any questions pertaining to the study, and to the extent of which I feel comfortable.

I understand that I may contact Lise Melbye (850)766-0949, her advisor Gershon Tenenbaum, PhD, (850)644-8791, or the human subjects committee (850)644-7900, with any further questions I may have regarding the research or my rights. Group results will be sent upon my request.

I have read and understand this consent form.

Name

Date

APPENDIX D

DEMOGRAPHIC INFORMATION

Please fill out the following information about yourself.

Age _____

Gender _____

Occupation _____

Race _____

APPENDIX E
SELF-OBJECTIFICATION QUESTIONNAIRE

Instructions:

I am interested in how people think about their bodies. Below are 10 different body attributes. I would like you to rank order these body attributes from that which has the *greatest* impact on your physical self-concept, to that which has the *least* impact on your physical self-concept.

Note: It does not matter how you describe yourself in terms of each attribute. For example, fitness level can have a great impact on your physical self-concept regardless of whether you consider yourself to be physically fit, not physically fit, or any level in between.

Please first read over all of the attributes. Then, record your rank by writing the letter of the attribute in the appropriate place on the scale, from most important to your physical self-concept, on down to least important.

- | | |
|--------------------------|--|
| a. physical coordination | f. physical attractiveness |
| b. health | g. energy level (e.g., stamina) |
| c. weight | h. firm/sculpted muscles |
| d. strength | i. physical fitness level |
| e. sex appeal | j. measurements (e.g., chest, waist, hips) |

LETTER OF ATTRIBUTE

MOST IMPORTANT..... _____
SECOND MOST IMPORTANT..... _____
THIRD MOST IMPORTANT..... _____
FOURTH MOST IMPORTANT..... _____
FIFTH MOST IMPORTANT..... _____
SIXTH MOST IMPORTANT..... _____
SEVENTH MOST IMPORTANT..... _____
EIGHTH MOST IMPORTANT..... _____
NINTH MOST IMPORTANT..... _____
LEAST IMPORTANT..... _____

APPENDIX F

OBJECTIFIED BODY CONSCIOUSNESS SCALE

Circle the number that corresponds to how much you agree with each of the statements on the following pages.

Circle NA only if the statement does not apply to you. Do not circle NA if you don't agree with a statement.

For example, if the statement says "When I am happy, I feel like singing" and you don't feel like singing when you are happy, then you would circle one of the disagree choices. You would only circle NA if you were never happy.

1. I rarely think about how I look.

Strongly disagree 1 2 3 4 5 6 7 strongly agree NA

2. When I can't control my weight, I feel like something must be wrong with me.

Strongly disagree 1 2 3 4 5 6 7 strongly agree NA

3. I think a person is pretty much stuck with the looks they are born with.

Strongly disagree 1 2 3 4 5 6 7 strongly agree NA

4. I think it is more important that my clothes are comfortable than whether they look good on me.

Strongly disagree 1 2 3 4 5 6 7 strongly agree NA

5. I feel ashamed of myself when I haven't made the effort to look my best.

Strongly disagree 1 2 3 4 5 6 7 strongly agree NA

6. A large part of being in shape is having that kind of body in the first place.

Strongly disagree 1 2 3 4 5 6 7 strongly agree NA

7. I think more about how my body feels than how my body looks.

Strongly disagree 1 2 3 4 5 6 7 strongly agree NA

8. I feel like I must be a bad person when I don't look as good as I could.

Strongly disagree 1 2 3 4 5 6 7 strongly agree NA

9. I think a person can look pretty much how they want to if they are willing to work at it.

Strongly disagree 1 2 3 4 5 6 7 strongly agree NA

10. I rarely compare how I look with how other people look.

Strongly disagree 1 2 3 4 5 6 7 strongly agree NA

11. I would be ashamed for people to know what I really weigh.

Strongly disagree 1 2 3 4 5 6 7 strongly agree NA

12. I really don't think I have much control over how my body looks.

Strongly disagree 1 2 3 4 5 6 7 strongly agree NA

13. During the day, I think about how I look many times.

Strongly disagree 1 2 3 4 5 6 7 strongly agree NA

14. I never worry that something is wrong with me when I am not exercising as much as I should.

Strongly disagree 1 2 3 4 5 6 7 strongly agree NA

15. I think a person's weight is mostly determined by the genes they are born with.

Strongly disagree 1 2 3 4 5 6 7 strongly agree NA

16. I often worry about whether the clothes I am wearing make me look good.

Strongly disagree 1 2 3 4 5 6 7 strongly agree NA

17. When I'm not exercising enough, I question whether I am a good enough person.

Strongly disagree 1 2 3 4 5 6 7 strongly agree NA

18. It doesn't matter how hard I try to change my weight, it's probably always going to be about the same.

Strongly disagree 1 2 3 4 5 6 7 strongly agree NA

19. I rarely worry about how I look to other people.

Strongly disagree 1 2 3 4 5 6 7 strongly agree NA

20. Even when I can't control my weight, I think I'm an okay person.

Strongly disagree 1 2 3 4 5 6 7 strongly agree NA

21. I can weigh what I'm supposed to if I try hard enough.

Strongly disagree 1 2 3 4 5 6 7 strongly agree NA

22. I am more concerned with what my body can do than how it looks.

Strongly disagree 1 2 3 4 5 6 7 strongly agree NA

23. When I'm not the size I think I should be I feel ashamed.

Strongly disagree 1 2 3 4 5 6 7 strongly agree NA

24. The shape you are in depends mostly on your genes.

Strongly disagree 1 2 3 4 5 6 7 strongly agree NA

APPENDIX G

SOCIAL PHYSIQUE ANXIETY SCALE

Please read each item and then indicate on the following scale the degree to which the statement is a characteristic of you.

1	2	3	4	5
not at all	slightly	moderately	very	extremely

1. _____ I wish I was not so uptight about my physique/figure.
2. _____ There are times when I am bothered by thoughts that other people are evaluating my weight or muscular development negatively.
3. _____ Unattractive features of my physique/figure make me nervous in certain social settings.
4. _____ In the presence of others, I feel apprehensive about my physique/figure.
5. _____ I am comfortable with how fit my body appears to others.
6. _____ It would make me uncomfortable to know others were evaluating my physique/figure.
7. _____ When it comes to displaying my physique/figure to others, I am a shy person.

APPENDIX H

EXERCISE BEHAVIOR SURVEY

Please answer the following questions by marking which answers most fit your behaviors when you exercise or participate in athletic situations. If you mark other, please fill in what the situation is in the space provided. Thank you.

1. On the average, I typically exercise _____ times a week:

_____0 _____1-2 _____3-4 _____5 or more

2. Each session I typically exercise for _____ minutes:

_____0-15 _____15-30 _____30-45 _____45-60 _____60 or more

3. When I exercise, the type of clothing I typically wear is _____ of my figure:

1	2	3	4	5
Very concealing	Moderately concealing	Wear concealing or revealing clothes equally	Moderately revealing	Very revealing

4. I prefer to exercise:

_____Alone _____With friends _____In a group setting, but not
necessarily with my friends

5. When I exercise, my favorite place to work out is:

_____At home _____Outdoors _____At the gym/
Public Facility _____Other: _____

6. If you most enjoy working outdoors or at the gym, what time of day do you ideally like to work out (not necessarily able to)

_____Before 9am _____9-12am _____12-4pm _____4-8pm _____After 8pm

7. The type of exercise that I typically do (mark as many as apply):

Weight training Running/Walking Cardio Machines

Ball Sports Yoga/Pilates Swimming

Aerobic Classes Karate/Martial Arts

Other: _____

REFERENCES

- Archer, D., Iriani, B., Kimes, D.D., & Barrios, M. (1983). Faceism: Five studies of sex differences in facial prominence. *Journal of Personality and Social Psychology*, *45*, 725-735.
- Bentler, M.P. (1990). Comparative fit indices in structural models. *Psychological Bulletin*, *112*, 400-404.
- Brewer, B.W., Diehl, N.S., Cornelius, A.E., Joshua, M.D., & Van Raalte, J.L. (2004). Exercising caution: Social physique anxiety and protective self-presentational behavior. *Journal of Science and Medicine in Sport*, *7*, 47-55.
- Browne, M.W. & Cudeck, R. (1993). Alternative ways of assessing model fit. In K.A. Bollen & J.S. Longs (Eds.), *Testing structural equation modeling* (pp. 136-162). Newbury Park, CA: Sage.
- Brownell, K.D. (1991). Dieting and the search for the perfect body: Where physiology and culture collide. *Behavior Therapy*, *22*, 1-12.
- Carron, A. V., & Prapavessis, H. (1997). Self-presentation and group influence. *Small Group Research*, *28*, 500-516
- Calogero, R.M. (2004). A test of objectification theory: The effect of the male gaze on appearance concerns in college women. *Psychology of Women Quarterly*, *28*, 16-21.
- Crawford, S., & Eklund, R.C. (1994). Social physique anxiety, reasons for exercise, and attitudes towards exercise settings. *Journal of Sport and Exercise Psychology*, *16*, 70-82.
- Daubenmier, J.J. (2002). *A comparison of Hatha yoga and aerobic exercise on women's body Satisfaction*. Unpublished doctoral dissertation, University of California at Berkeley, Berkeley, CA.
- Diehl, N.S., Johnson, C.E., Rogers, R.L., & Petrie, T.A. (1998). Social physique anxiety and disordered eating: What's the connection? *Addictive Behaviors*, *23*, 1-6.
- Dion, K.L., Dion, K.K. & Keelan, J.P. (1990). Appearance anxiety as a dimension of social-evaluative anxiety: Exploring the ugly-duckling syndrome. *Contemporary Social Psychology*, *14*, 220-225.
- Eklund, R.C., & Crawford, S. (1994). Active women, social physique anxiety, and exercise. *Journal of Sport and Exercise Psychology*, *16*, 431-448.
- Finkenber, M.E., DiNucci, J., McCune, S.L., Chenette, T., & McCoy, P. (1998). Commitment to physical activity and anxiety about physique among college women. *Perceptual and Motor Skills*, *87*, 1393-1394.

- Frederick, C.M. & Morrison, C.S. (1996). Social physique anxiety: Personality constructs, motivations, exercise attitudes and behaviors. *Perceptual and Motor Skills*, 82, 963-972.
- Fredrickson, B.L., Roberts, T.-A.. (1997). Objectification theory: Toward understanding women's lived experiences and mental health risks. *Psychology of Women Quarterly*, 21, 207-226.
- Fredrickson, B.L., Roberts, T.-A., Noll, S.M., Quinn, D.M., & Twenge, J.M. (1998). That swimsuit becomes you: Sex differences in self-objectification, restrained eating, and math performance. *Journal of Personality and Social Psychology*, 75, 269-284.
- Garner, D.M. (1991). Eating Disorder Inventory-2 manual. Odessa FL: Psychological Assessment Resources.
- Greenleaf, C. (2005). Self-objectification among physically active women. *Sex Roles*, 52, 51-62.
- Haase, A.N., Prapavesis, H., & Owens, G.R. (2002). Perfectionism, social physique anxiety and disordered eating: A comparison of male and female elite athletes. *Psychology of Sport and Exercise*, 3, 209-222.
- Hamilton, K., & Waller, G. (1993). Media influences on body size estimation in anorexia and bulimia. *British Journal of Psychiatry*, 162, 837-840.
- Hart, E.H., Leary, M.R., & Rejeski, W.J. (1989). The measurement of social physique anxiety. *Journal of Sport and Exercise Psychology*, 11, 94-104.
- Hausenblas, H.A., Brewer, B.W., & Van Raalte, J.L. (2004). Self-presentation and exercise. *Journal of Applied Sport Psychology*, 16, 3-18.
- Hausenblas, H.A., & Mack, D.E. (1999). Social physique anxiety and eating disorder correlates among female athletic and nonathletic populations. *Journal of Sport Behavior*, 22, 502-513.
- Holt, K., & Ricciardelli, L.A. (2002). Social comparisons and negative affect as indicators of problem eating and muscle preoccupation among children. *Applied Developmental Psychology*, 23, 285-304.
- Klaczynski, P., Goold, K., & Mudry, J. (2004). Culture, obesity stereotypes, self-esteem, and the "thin ideal": A social identity perspective. *Journal of Youth and Adolescence*, 33, 307-317.
- Krane, V., Stiles-Shipley, J.A., Waldron, J., & Michalenok, J. (2001). Relationships among body satisfaction, social physique anxiety, and eating behaviors in female athletes and exercisers. *Journal of Sport Behavior*, 24, 247-265.
- Lantz, C.D., Hardy, C.J., & Ainsworth, B.E. (1997). Social physique anxiety and perceived

- exercise behavior. *Journal of Sport Behavior*, 20, 83-93.
- Leary, M.R. (1992). Self-presentational processes in sport. *Journal of Sport & Exercise Psychology*, 14, 339-351.
- McAllister, R., & Caltabiano, M.L. (1994). Self-esteem, body-image and weight in non-eating disordered women. *Psychological Reports*, 75, 1339-1343.
- McArdle, W.D., Katch, F.I., & Katch, V.L. (2001). *Exercise physiology: Energy, nutrition, and human performance* (5th ed.). Baltimore: Lippincott, Williams & Wilkins.
- McAuley, E., Bane, S.M., Rudolph, D.L., & Lox, C.L. (1995). Physique anxiety and exercise in middle-aged adults. *Journals of Gerontology: Psychological Sciences and Social Sciences*, 50, 229-235.
- McKinley, N.M. (1999). Women and objectified body consciousness: Mothers' and daughters' body experience in cultural, developmental, and familial context. *Developmental Psychology*, 35, 760-769.
- McKinley, N.M. & Hyde, J.S. (1996). The objectified body consciousness scale: Development and validation. *Psychology of Women Quarterly*, 20, 181-215.
- Miner-Rubino, K., Twenge, J.M., & Fredrickson, B.L. (2002). Trait self-objectification in women: Affective and personality correlates. *Journal of Personality Research*, 36, 147-172.
- Motl, R.W. & Conroy, D.E. (2000). Validity and factorial invariance of the social physique anxiety scale. *Medicine and Science in Sport and Exercise*, 32, 1007-1017.
- Muehlenkamp, J.J., & Saris-Baglama, R.N. (2002). Self-objectification and its psychological outcomes for college women. *Psychology of Women Quarterly*, 26, 371-379.
- Noll, S.M. (1996). *The relationship between sexual objectification and disordered eating: Correlational and experimental tests of body shame as a mediator*. Unpublished doctoral dissertation, Duke University, Durham, NC.
- Noll, S.M., & Fredrickson, B.L. (1998). A mediational model linking self-objectification, body shame, and disordered eating. *Psychology of Women Quarterly*, 22, 623-636.
- Ricciardelli, L.A., & McCabe, M.P. (2001). Children's body image concerns and eating disturbance: A review of the literature. *Clinical Psychology Review*, 21, 325-344.
- Roberts, T., & Gettman, J.Y. (2004). Mere exposure: Gender differences in the negative effects of priming a state of self-objectification. *Sex Roles*, 51, 17-27.
- Russell, W.D., & Cox, R.H. (2003). Social physique anxiety, body dissatisfaction, and self-

- esteem in college females of differing exercise frequency, perceived weight discrepancy, and race. *Journal of Sport Behavior*, 26, 298-318.
- Schlenker, B.R., & Leary, M.R. (1982). Social anxiety and self-presentation: A conceptualization and model. *Psychological Bulletin*, 92, 641-669.
- Scott, L.A., Burke, K.L., Joyner, A.B., & Brand, J.S. (2004). Examining the stability of the 7-item social physique anxiety scale using a test-retest method. *Measurement in Physical Education Exercise Science*, 8, 57-62.
- Slater, A., & Tiggemann, M. (2002). A test of objectification theory in adolescent girls. *Sex Roles*, 46, 343-349.
- Sommers-Flanagan, R., Sommers-Flanagan, J., & Davis, B. (1993). What's happening on music television? A gender role content analysis. *Sex Roles*, 28, 745-755.
- Spink, K.S. (1992). Relation of anxiety about social physique to location of participation in physical activity. *Perceptual and Motor Skills*, 74, 1075-1078.
- Strelan, P., Mehaffey, S.J., & Tiggemann, M. (2003). Self-objectification and esteem in young women: The mediating role of reasons for exercise. *Sex Roles*, 48, 89-95.
- Tate, R.L. (1998). *An introduction to modeling outcomes in the behavioral and social sciences* (2nd ed.). Edina, Minnesota: Burgiss.
- Thompson, A.M., & Chad, K.E. (2002). The relationship of social physique anxiety to risk for developing an eating disorder in young females. *Journal of Adolescent Health*, 31, 183-189.
- Tiggemann, M., & Lynch, J.E. (2001). Body image across the life span in adult women: The role of self-objectification. *Developmental Psychology*, 37, 243-253.
- Walton, V.R., & Finkenber, M.E. (2002). Women's anxiety about social and exercise settings. *Perceptual and Motor Skills*, 94, 700-702.
- Yin, Z. (2001). Setting for exercise and concerns about body appearance of women who exercise. *Perceptual and Motor Skills*, 93, 851-855.

BIOGRAPHICAL SKETCH

Lise Melbye was born and raised in Boulder, Colorado, and graduated from Fairview High School. She attended Colorado College in Colorado Springs, CO, where she continued her diving career, participating on the team all four years. She was a captain her senior year, and a national qualifier on the 3-meter springboard. Through college she was also a member of the Pikes Peak All Star Bowlers, carrying the high average for women 3 of her 4 years. She studied abroad for a semester during her junior year in Brisbane, Australia, at the University of Queensland. She graduated with a Bachelors of Arts, with a major in Psychology and a minor in Anthropology. She earned her Master's degree in Sport Psychology at Florida State University, where she participated on the club bowling team for a year, participated in intramurals sports, and enjoyed 5k road races.